



HAL
open science

Seismic High-Resolution Acquisition Electronics for the NASA InSight Mission on Mars

Peter Zweifel, Davor Mance, Jan ten Pierick, Domenico Giardini, Cedric Schmelzbach, Thomas Haag, Tobias Nicollier, Savas Ceylan, Simon Stähler, Martin van Driel, et al.

► **To cite this version:**

Peter Zweifel, Davor Mance, Jan ten Pierick, Domenico Giardini, Cedric Schmelzbach, et al.. Seismic High-Resolution Acquisition Electronics for the NASA InSight Mission on Mars. *Bulletin of the Seismological Society of America*, 2021, 111 (6), pp.2909-2923. 10.1785/0120210071 . hal-03917211

HAL Id: hal-03917211

<https://u-paris.hal.science/hal-03917211v1>

Submitted on 23 Sep 2023

HAL is a multi-disciplinary open access archive for the deposit and dissemination of scientific research documents, whether they are published or not. The documents may come from teaching and research institutions in France or abroad, or from public or private research centers.

L'archive ouverte pluridisciplinaire **HAL**, est destinée au dépôt et à la diffusion de documents scientifiques de niveau recherche, publiés ou non, émanant des établissements d'enseignement et de recherche français ou étrangers, des laboratoires publics ou privés.

Public Domain



Seismic High-Resolution Acquisition Electronics for the NASA InSight

Mission on Mars

P. Zweifel^{1,*}, D. Mance¹, J. ten Pierick¹, D. Giardini¹, C. Schmelzbach¹, T. Haag¹, T. Nicollier⁶,
S. Ceylan¹, S. Stähler¹, M. van Driel¹, D. Sollberger¹, F. Euchner¹, J.F. Clinton¹, M. Bierwirth²,
M. Eberhardt², P. Lognonné³, W.T. Pike⁴, W.B. Banerdt⁵

* Corresponding author: Peter Zweifel, Institute of Geophysics, ETH Zurich, c/o Schachenstrasse
39a, 8633 Wolfhausen, Switzerland, +41 79 572 85 82, peter.zweifel@retired.ethz.ch

¹ Eidgenössische Technische Hochschule Zürich

² Max-Planck-Institute for Solar System Research, Göttingen

³ Institut de Physique du Globe de Paris

⁴ Imperial College London

⁵ Jet Propulsion Laboratory / California Institute of Technology

⁶ Eidgenössische Forschungsanstalt WSL, Birmensdorf

Declaration of Competing Interests

The authors acknowledge there are no conflicts of interest recorded.

Abstract

The InSight (Interior exploration using Seismic Investigations, Geodesy and Heat Transport) seismometer instrument SEIS (Seismic Experiment for Interior Structure) was deployed on Mars in December 2018 and went into scientific operation mode starting from March 2019. The

23 Acquisition and Control electronics (AC) is a key element of SEIS. The AC acquires the seismic
24 signals of the two sets of seismic sensors with high resolution, stores the data in its local non-
25 volatile memory for later transmission by the lander and controls the numerous functions of
26 SEIS. In this paper, we present an overview of the AC with its connections to the sensors and to
27 the lander, as well as its functionality. We describe the elements of the acquisition chains and
28 filters, and discuss the performance of the seismic and temperature channels. Furthermore, we
29 outline the safety functions and health monitoring, which are of paramount importance for
30 reliable operation on Mars. In addition, we analyze an artefact affecting the seismic data referred
31 to as the ‘tick-noise’, and provide a method to remove this artefact by post-processing the data.

32

33 [Introduction](#)

34 NASA InSight landed on Mars on November 26, 2018 (Banerdt et al., 2020). The InSight lander
35 is equipped with three instruments:

- 36 • SEIS: consisting of a very broadband (VBB) and one short period (SP) seismometer each
37 with three components (P. Lognonné, 2019)
- 38 • HP³: Heat Flow and Physical Properties Package (Spohn et al., 2018)
- 39 • RISE: Rotation and Interior Structure Experiment (Folkner et al., 2018)

40 SEIS is the primary instrument of the mission. Between December 2018 and March 2019, after
41 initial operation of the lander, SEIS was commissioned, configured and deployed on the surface
42 of Mars, and then began scientific operation.

43 SEIS consists of three main parts:

- 44 • the Sensor Assembly (SA), which was placed on the ground by the InSight’s robotic arm
- 45 • the Electronics Box (E-Box), which resides in the temperature-controlled lander
46 compartment, called the Warm Electronics Box (WEB)

47 • the tether connecting the SA to the E-Box

48 The SA incorporates the seismic sensors, the leveling mechanism and a thermal protection
49 (Figure 1). Three identical, oblique-oriented VBB sensor axes are located in a vacuum sphere
50 and mounted on the ring-shaped leveling structure (LVL). Each VBB sensor has a proximity
51 electronics attached to the LVL. One vertical and two horizontal SP sensors are fixed on the
52 outer side of LVL separated at angles of 120 degrees. The LVL has three extendable legs, which
53 can be adjusted in order to level the SA on a slope of up to 15 degrees. (A detailed description of
54 the SEIS instrument can be found in (P. Lognonné, 2019)).

55 There are temperature sensors installed on each of the VBB and SP sensors, in the VBB
56 proximity electronics and on the structure. The latter is used to measure the SA temperature with
57 high resolution for decorrelation purposes. Each VBB sensor includes a motor driven mass
58 centering and a temperature compensation mechanism. The LVL is equipped with motors to
59 move the legs, supported by coarse and high-precision tilt-meters. Heaters are attached to the
60 inner side of the LVL ring to keep the SA temperature above -65 °C and thus within the safe
61 operating temperature range. A double-walled thermal enclosure (RWEB) covers and protects
62 the entire SA. After deployment on ground, a Wind and Thermal Shield (WTS) is placed over
63 the SA to complete the protection and insulation of the sensitive sensors.

64 The tether is the electrical connection between the SA and the E-Box. It is a 3 m long semi-rigid,
65 layered flat cable (partially visible in Figure 1) carrying about 200 wires for the sensor signals,
66 power and ground connections, control signals, measurement signals, motor drive lines for
67 leveling, mass-centering, etc.

68 Here, we give a brief description of the SEIS electronics. We then describe the seismic data
69 acquisition channels and processing chain. We present the acquisition performance of the
70 seismic and the temperature channels. Finally, we describe an artefact caused by the electronics,

71 which we refer to as the “tick noise”, and provide a method of removing it from the seismic
72 dataset.

73 SEIS Electronics

74 The E-Box comprises all SEIS electronics, except the VBB proximity electronics, some
75 electronics inside the SP sensors and the high precision tiltmeter front end electronics mounted
76 on the LVL. The E-Box is located in a triangle-shaped space in the WEB, hanging upside down
77 below the lander deck. The WEB contains most of the lander and instrument electronics and is
78 heated to prevent temperatures to fall below -35 °C. The picture in Figure 2 shows the E-Box
79 Flight Model (FM) unit in preparation for the thermal test.

80 The E-Box is implemented as a modular structure and includes all SEIS boards (see exploded
81 view in Figure 2):

- 82 - Power distribution and conditioning electronics (DC), two boards
- 83 - Acquisition electronics (ACQ), one board
- 84 - Control electronics (CTL), two boards
- 85 - VBB Feedback electronics VBB-FB[123], three boards
- 86 - SP Feedback electronics SP-FB, one board for all three axes
- 87 - Leveling Motor Drive Electronics LVL-MDE, one board

88 The Acquisition and Control electronics (AC) consists of the ACQ, CTL and DC boards. It
89 constitutes a sophisticated seismic data logger that provides, besides the high-resolution
90 acquisition of seismic sensors, the power for the instrument and a variety of functions to run the
91 instrument fully remote controlled in the environment of Mars as described later in this paper. It
92 is the core of the SEIS instrument and provides interfaces to the Command & Data Handling
93 Unit (C&DH) and Power Distribution & Drive Unit (PDDU) on the lander side, and to the
94 instrument’s sub-systems (VBB and SP sensors, LVL).

95 Since SEIS is the primary instrument of the InSight mission, reliability is paramount. The
96 instrument has to withstand "single-point failures". This is accomplished by duplicating vital
97 parts of the instrument. The two sensor packages (VBB and SP) with their associated electronics
98 meet this requirement, since an SP sensor can replace a defective VBB sensor to a certain extent
99 and vice versa. Their associated electronics consist of the sensor feedback electronics and the
100 acquisition front-end circuits of the AC, with the latter providing signal conditioning and the
101 analog-to-digital conversion.

102 The AC, which is the central part of the instrument, is duplicated except for the aforementioned
103 front-end circuitry and the LVL-MDE electronics. This means that there are two identical
104 electronics, called the A-side and B-side of the AC. In the event of a fault, the B-side can
105 substitute the defective A-side or vice versa. The A-side is used for nominal operation. The
106 sensor and associated electronics as well as the LVL-MDE are connected to both sides of the
107 AC. The PDDU supplies the SEIS instrument with four +28 V primary power lines. Two of
108 these lines are connected to the A-side and two to the B-side of the AC. The C&DH (likewise
109 duplicated) controls the PDDU switches so that one of the four power lines is powered-up,
110 activating the corresponding A or B side of the AC.

111 The LVL MDE board is not duplicated due to volume and mass constraints in the WEB and
112 limitations on the number of wires in the cable. The associated risk is considered acceptable
113 because sensor leveling is rarely used and is only activated when temperatures are highest on
114 Mars.

115 As a further safety measure, each sensor-axis can be switched off individually to isolate
116 defective sensors or circuits. Automatic over-current protection circuits switch off parts or all of
117 the electronics. To detect potential problems or adverse trends, numerous housekeeping channels
118 measure currents, voltages and temperatures in the various instrument parts. The housekeeping

119 data is stored and downlinked to Earth for health monitoring by the instrument operation
120 engineers.

121 The block diagram in Figure 2 shows the main connections within the SEIS instruments to the
122 spacecraft and to the Auxiliary Payload Sensor Suite (APSS) (see Banfield, 2018). The DC
123 boards convert the primary power into several positive and negative supply voltages required by
124 the AC and the sub-systems. The duplicated interfaces to the lander computers C&DH A and
125 C&DH B are cross-strapped and consist of a low speed serial line for commands and special
126 data, and a serial 4 Mbit/s line for the high-speed transmission of acquired sensor and health data
127 to the lander for further processing or downlink to Earth.

128 The SEIS command dictionary incorporates eighty commands with various parameters to cover
129 all functions of the SEIS instrument, such as turning on sub-systems, starting/stopping the
130 acquisition, configuring sampling rates and gains, retrieving specific data, and so on. The APSS
131 receives a 1-second pulse from SEIS. This pulse is used to time-correlate the APSS data with
132 SEIS data.

133

134 [Seismic Acquisition Channels](#)

135 There are nine seismic acquisition channels. The VBB sensors provide three velocity and three
136 position signals, the SP sensors three velocity signals. Each of these signals is digitized by a
137 dedicated 24-bit sigma-delta Analog-to-Digital Converter (ADC) and then filtered, time-stamped
138 and stored in the on-board non-volatile memory. The lander computer C&DH retrieves the data
139 regularly and then processes and stores the data in its mass memory. The acquired and processed
140 data can then be downlinked to Earth on request.

141 Acquisition Chain

142 The acquisition chain consists of the conditioning electronics (amplifier/filter), the ADC and the
143 Finite Impulse Filter (FIR; see block diagram in Figure 3). The conditioning electronics in front
144 of the ADC scales the seismic signals from the sensor full-scale range to the input voltage range
145 of the ADC. The full-scale ranges are ± 25 Volt for the VBBs (for both velocity and position
146 signals) and ± 12.5 Volt for the SP velocity signals. In addition, the conditioning electronics
147 filters the signal by the second-order low pass filter, which is the first part of a 3-step anti-
148 aliasing filter. To reduce the low frequency ($1/f$) noise, low offset, zero drift (auto zero)
149 amplifiers are used.

150 Analog-to-Digital Conversion

151 The performance requirement “seismic signals with a dynamic range of at least 130 dB in
152 amplitude” require the use of a 24-bit ADC. At the time the InSight development began in 2012,
153 24-bit ADC’s were state-of-the-art in seismic data loggers and in industry in general, but not
154 common in space projects. The challenge for these rather complex integrated circuits is to sustain
155 the impact of cosmic radiation in space when departing the protective magnetosphere of Earth,
156 and after landing on Mars. The 24-bit sigma-delta ADC AD7712 was finally selected for SEIS
157 due to its robustness with respect to radiation and its availability in MIL quality (military
158 temperature range and ceramic packaging). The device passed the radiation tests without any
159 permanent destruction although it showed some malfunctions that altered configuration registers
160 and interrupted the conversion. These failure conditions are managed in operation by monitoring
161 and rewriting the ADC’s configuration registers.

162 The ADC converts the signals with an input sampling rate of 32 kHz. The on-chip 3rd order sinc-
163 in-time filter (sinc^3) is followed by a decimation by a factor of 64 for the velocity channels and
164 by a factor of 3200 for the position channels. The corresponding ADC output rates are thus

165 500 Hz for VBB and SP velocity and 10 Hz for VBB position. This sinc^3 filter constitutes the
166 second stage of the anti-aliasing filtering.

167 FIR Filter

168 The FIR filters, implemented in the Field Programmable Gate Array (FPGA), apply a sharp low-
169 pass filter, which allows decimating the filter output data to the final output rates. For the VBB
170 and SP velocity channels, a sampling rate of 100 Hz or 20 Hz is selectable. The upper diagram in
171 Figure 4 shows the corresponding filter layout. If 100 Hz data is selected, only stage 1 is used,
172 i.e., the output samples of stage 1 will end up in the data packet. If 20 Hz data is selected, both
173 stages are used and the output samples of stage 2 will end up in the data packet.

174 For the VBB position and Scientific Temperature SCIT (LVL temperature) channels, the
175 sampling rates of 1 Hz and 0.1 Hz are available. The corresponding filter layout is shown in the
176 lower diagram in Figure 4.

177 The FIR filter is the third and last stage of the anti-aliasing filtering. The standard filter used for
178 seismic recordings is identical to the terrestrial broadband seismological station CI.PFO (refer to
179 P. Lognonné, 2019).

180 The data samples of the seismic and the temperature channels are buffered and then 1-second
181 data packets are constructed from them. These packets are time-stamped with the Local On-
182 Board Time (LOBT) that corresponds to the instant when the first sample of the 1-second data
183 packet was acquired. The packets are stored in the FLASH memory, which can hold more than
184 65 hours of data. The FLASH memory is organized as a ring buffer; i.e., as soon as the memory
185 is filled-up, the oldest data is overwritten.

186 Anti-aliasing Filter

187 The resulting anti-aliasing filter is the product of the three filter steps mentioned in the previous
188 sections. The first two steps are implemented as hardware, only the FIR filter in FPGA can be

189 configured. Figure 3 left side shows the individual attenuation of each of the three filter steps up
190 to 600 Hz.

191 It can be seen that the FPGA filters do not suppress signals with a frequency of $500 \text{ Hz} \pm 8 \text{ Hz}$,
192 as these signals appear in the pass band due to folding around the ADC Nyquist frequency of
193 250 Hz. However, this effect coincides with the notch of the ADC filters at 500 Hz. Therefore,
194 the total attenuation of the cascaded filters remains at almost 120 dB for frequencies above the
195 pass band (see Figure 3 right hand side). The contribution of the analog filter (first filter step) is
196 less than 10 dB in the frequency range shown.

197 [FIR Filter upload](#)

198 The FIR filter coefficients can be uploaded from Earth via the lander and changed for certain
199 channel groups. Channel groups are VBB velocity channels, SP velocity channels, VBB position
200 channels and the SCIT channel. This capability is used to change filters for special purposes, as
201 for example, to achieve an extended bandwidth as described in the section ‘Strategies to record
202 information beyond the Nyquist frequency of 50 Hz’.

203 [Channel Noise Performance](#)

204 The acquisition noise is a result of the amplifier noise of the signal conditioning, the intrinsic
205 noise of the ADC and the voltage reference noise (Figure 5). The ADC intrinsic noise of
206 $3.8 \mu\text{V}/\sqrt{\text{Hz}}$ is flat (white) down to 10 mHz, below which the ADC $1/f$ noise becomes visible.
207 Above about 8 Hz, the ADC quantization noise starts to dominate over the ADC white noise and
208 becomes therefore visible at 100 Hz data rate up to the FIR filter corner frequency of 40 Hz.
209 A space qualified external voltage reference (RH1021-5), with a temperature sensitivity of
210 $<5 \text{ ppm/K}$ is used to achieve good stability. It has a low noise, matching the ADC performance.
211 The acquisition noise level at low frequencies ($<100 \text{ mHz}$) depends on the input signal amplitude
212 since the voltage reference noise is proportionally scaled with the acquired signal. For signals

213 less than about 25% of the full-scale range (FSR), the voltage reference noise is not significant
214 w.r.t. the intrinsic noise of ADC (Figure 5). For the 20 Hz data rate, the FIR filter with 8 Hz
215 corner frequency will completely attenuate the quantization noise. (See also P. Lognonné et al,
216 2019)

217 Measured VBB channel performance

218 To illustrate the measured performance of the acquisition system, we compare the electrical
219 noise of the acquisition channels obtained during the electrical tests with the seismic noise
220 recorded during a very quiet period on Mars. The results are displayed in $V/\sqrt{\text{Hz}}$ (amplitude
221 spectrum density) and are referred to the inputs of the acquisition system.

222 When the E-Box is fully assembled, the inputs of the recording system are not accessible
223 anymore. Therefore, we present noise results recorded during the electronics tests before
224 integration of the sensor feedback electronics, i.e., during the so-called board level tests in the
225 manufacturing phase. The test configuration only includes the AC part of the E-Box (see section
226 ‘SEIS Electronics’). The corresponding spectra in the diagrams are labeled "Channel AC". The
227 noise requirement for the acquisition channels is shown with the red line.

228 The right panel in Figure 6 shows the VBB velocity channels recorded with a sampling rate of
229 100 Hz. The Mars data was acquired on 2020-02-04 at 17:52 for 15 min (between 21:00-22:00
230 on Sol 423 – an extremely quiet time with minimal wind noise). The tick-noise artefact was
231 removed from the Mars data (the tick-noise and the removal procedure is described in detail in
232 section ‘1-Hz Mode (Tick-noise)’). In addition to the VBB sensor data, the acquisition system
233 data, in which the sensor noise is not present, was acquired prior to the mission on 2014-10-16
234 for 15 min during the board level test of the FM electronics. The acquisition noise corresponds to
235 the ADC intrinsic noise as shown in Figure 5 up to about 8 Hz. The ADC quantization noise

236 becomes dominant above 8 Hz and increases up to the corner frequency of the FIR filter, as
237 explained in the section above.

238 In the left panel of Figure 6, VBB position channels with a sampling frequency of 1 Hz are
239 compared. The Mars data was acquired on 2019-10-18 at 20:00 for 59 min, while the acquisition
240 system data was recorded on 2014-10-04 for 59 min. Above ~0.15 Hz, the sensor noise becomes
241 equal to or smaller than the acquisition noise.

242 Measured SP channel performance

243 The acquisition channels for the SP are identical to the VBB channels except that the full-scale
244 range is reduced by half to $\pm 12.5V$. Therefore, the noise limit is lowered accordingly. Figure 7
245 shows the horizontal SP channels recorded during cruise on 2018-07-16 at 15:48 for 7 min and
246 all three SP channels on Mars (2019-01-12 at 05:10 for 15 min), as well as the recorded
247 acquisition channels during instrument board level test of the FM electronics on 2014-10-16 for
248 15 min, all with sampling frequency of 100 Hz. The cruise recordings show only the horizontal
249 SP sensors as they work well in zero gravity environment. In contrast, the vertical SP sensor
250 requires gravity to function. The shown noise spectra of the two horizontal SP sensors
251 correspond to their self-noise, as there is no source of vibration on the spacecraft during cruise
252 phase.

253 As explained in section ‘Channel Noise Performance’, and therefore expected, the ADC
254 quantization noise dominates the acquisition noise above 8 Hz.

255 Linearity (INL)

256 As part of an instrument performance campaign, the Integral Non-Linearity (INL) of the
257 acquisition channels on the flight spare (exact duplicate of the flight unit on Mars) was
258 measured. A defined precise voltage V_{ref} was applied in steps to the differential inputs of the
259 VBB channels (see block diagram in Figure 8). The voltages were acquired by the acquisition

260 electronics AC and additionally measured by a high-precision Digital Multi-Meter (DMM) to
261 obtain a better knowledge about the input voltage. The measurements were carried out for all
262 VBB channels before feedback board integration. For each tested input voltage, 10 seconds of
263 data were sampled from all VBB channels at the highest sampling rate (i.e., 100 Hz for the
264 velocity channels and 1 Hz for the position channels). The DMM was configured at fixed input
265 range to maintain stable gain and offset during the test.

266 The analysis of the results was done separately for each VBB channel. First, the straight line
267 between the range end-points is determined by calculating a gain and an offset, such that the
268 digital number returned for the channel relates to the input voltage as follows:

269 1)

$$VBBchan = gain * V_{input} - offset$$

271 The offset and gain are determined by the following formulae:

272 2)

$$gain = \frac{VBBchan(20V) - VBBchan(-20V)}{V_{input}(20V) - V_{input}(-20V)}$$

274 3)

$$offset = VBBchan(-20V) - gain * V_{input}(-20V)$$

276 where the values between parentheses are the applied voltage. V_{input} refers to the value measured
277 with the DMM. The endpoints of -20 V and +20 V correspond to the specified input voltage
278 range.

279 For each input voltage set, the error is calculated:

280 4)

$$\varepsilon = VBBchan - gain * V_{input} - offset$$

282 The INL in percentage of the full-scale range using the maximum error measured, called ε_{max} :

283 5)

284
$$INL = 100 * \frac{\varepsilon_{max}}{VBBchan(20V) - VBBchan(-20V)}$$

285 Figure 8 shows the measured errors for all VBB channels for the specified range extended by
286 10%, from which can be seen that the acquisition is still linear for signals slightly beyond the
287 specified range.

288 The highest INL measured is about $3.2 \cdot 10^{-4}$ % for the VBB1 velocity channel, and this is well
289 below $15 \cdot 10^{-4}$ %, the maximum INL in the ADC (AD7712) specification. A typical INL of
290 $3 \cdot 10^{-4}$ % is specified for the ADC, and the results for all channels are close to this value. The
291 non-linearity measured is according to what can be expected from the ADC. Thus, no significant
292 contribution from the conditioning electronics is observed. However, we are also at the limits of
293 the measurement setup itself. Therefore, the non-linearity observed may not only reflect the
294 performance of the acquisition system, but also include limitations of the instrumentation and the
295 setup used to obtain the result.

296

297 [Temperature Acquisition Channels](#)

298 There are three temperature measurement systems in the SEIS instrument:

- 299 - Scientific Temperature (SCIT A&B): Two thermistors (PT1000) mounted on the ring of
300 the leveling structure. There are two, SCIT A and SCIT B, each connected to the
301 corresponding AC side.
- 302 - VBB Engineering Temperature: Three thermistors, mounted on the three VBB sensors
303 providing the sensor temperature
- 304 - Housekeeping Temperatures

305 *Scientific Temperature (SCIT)*

306 The SCIT is the tenth high-resolution channel of AC with a dedicated 24-bit ADC. Like the VBB
307 POS channels, the SCIT is digitized with 32 kHz sample rate and provides, after ADC filtering
308 and FIR filtering of the FPGA, the output rates of 1 Hz or 0.1 Hz. This high precision
309 temperature measurement is implemented as a 4-wire measurement, meaning the two excitation
310 lines to the thermistor are separated from the two sensing lines, to avoid voltage drop affecting
311 the measurement due to long wires. Figure 9 shows the time-series (left) and the Amplitude
312 Spectrum Density (ASD) (right) of measurements made during final testing of the E-Box FM
313 electronics. In order to assess the performance of the circuit using a stable input signal, a resistor
314 with a fixed and stable value replaced the temperature sensing thermistor.
315 The transfer function of the SCIT temperature measurement including the non-linear thermistor
316 can be found in (P. Lognonné, 2019).

317 *VBB Engineering Temperature (VBB[1,2,3] ENG TEMP)*

318 The VBB engineering temperature measurement is a 2-wire measurement, using the same lines
319 for excitation and sensing. Unlike the seismic channels and the SCIT that have a dedicated ADC,
320 the three engineering temperature channels share a single ADC that acquires them in sequence.
321 A multiplexer scans through all channels and a calibration resistor of 1 k Ω . For each channel and
322 the calibration resistor, the ADC acquires 16 samples, which are averaged. In a second step, an
323 offset compensation is applied with equation (6).

324 6)

$$325 \quad VBBx_{Temp} = VBBx_{avg} + (RefConst - Cal_{avg})$$

326 $VBBx_{Temp}$ = Engineering Temperature Result for each channel, $x = 1 \dots 3$

327 $VBBx_{avg}$ = averaged 16 ADC samples for each channel, $x = 1 \dots 3$

328 RefConst = Reference constant representing 1 k Ω

329 Cal_{avg} = averaged 16 ADC samples measured on calibration resistor of 1 k Ω

330 In contrary to the SCIT channel that is a continuous stream, the VBB engineering temperature
331 channels are a series of point measurements. There is no post-filtering as with the SCIT channel.

332 The noise performance, measured at a sample rate of 1 Hz with a fix resistor, is 1.5 mK/ $\sqrt{\text{Hz}}$
333 over the frequency band from 0.5 Hz down to 0.01 mHz and is well below the requirement of
334 3 mK/ $\sqrt{\text{Hz}}$.

335 The conversion factors including the non-linear thermistor can be found in (P. Lognonné, 2019).

336 [Housekeeping Temperatures](#)

337 The housekeeping temperatures are a third category of temperature measurements. They are
338 designed to provide the temperatures of sensors and electronics boards in the instrument for
339 diagnostic purposes. They are collected together with the voltage and current measurements with
340 a resolution of 12-bits.

341 [Time Base](#)

342 The acquisition clock is derived from the AC master clock, which is based on the Hybrid Crystal
343 Oscillator QT625LEM-32.768000MHz QTH U. The acquisition is therefore free-running with
344 respect to the spacecraft clock and the Universal Time Coordinated (UTC). The oscillator
345 temperature sensitivity is up to ~ 1 ppm/ $^{\circ}\text{C}$ according manufacturer's temperature sensitivity
346 curve. The estimated drift is then between -20 ppm and +5 ppm in the maximum temperature
347 range of -35 $^{\circ}\text{C}$ to +50 $^{\circ}\text{C}$ specified for E-Box. The acquired data is time stamped with the Local
348 On-Board Time (LOBT), which is derived as well from the master clock. This time is kept by a
349 40-bit counter with a resolution of 1/1024 s. The value of this counter is included as time stamp
350 in the 1-second packets.

351 The time correlation between the LOBT and UTC is performed in post-processing. This is done
352 in two steps. The LOBT is correlated with the spacecraft clock (SCLK). For this purpose, the AC

353 receives the spacecraft clock SCLK together with a synchronization pulse from the lander. This
354 is used to generate pairs of LOBT/SCLK from the same instant in time, which are retrieved by
355 the lander. Then the SCLK time is correlated with UTC using time pairs from the X-band
356 communication.

357 [Strategies to record information beyond the Nyquist frequency of 50 Hz](#)

358 For specific seismic investigations, it is of interest to record seismic signals with a frequency
359 content exceeding the effective bandwidth of 0 - 40 Hz (considering the low-pass -3dB corner)
360 with a Nyquist frequency of 50 Hz dictated by the 100 Hz sampling frequency. For example, the
361 eigen-modes of the LVL show eigen-frequencies >50 Hz (Lognonné et al., 2020). Furthermore,
362 the hammering of the HP³ mole into the ground to measure a vertical thermal conductivity
363 profile will generate signals > 50 Hz that may allow inferring on elastic properties of the shallow
364 Martian crust (Kedar et al., 2017; Golombek et al., 2018; Brinkman et al., 2019). Changing the
365 FIR filters of stage 1 in the velocity signal acquisition chain (Figure 4 upper diagram) allows
366 recording information outside the effective frequency bandwidth of 0 - 40 Hz.

367 A straightforward way to extend the bandwidth of SEIS is to exploit the fact that, following the
368 Nyquist sampling theorem, the sampling limitations are not dictated by the maximum frequency,
369 but by the bandwidth of the signal. Any signal that is constrained to a bandwidth of 50 Hz with a
370 minimum frequency of an integer multiple of 50 Hz can therefore be exactly reconstructed when
371 sampled at a sampling rate of 100 Hz. For example, changing the FIR filter of a velocity channel
372 to pass 50 - 100 Hz at stage 1 will lead to the data being aliased once (Figure 10). The original
373 information can then be recovered by re-mapping the information that mapped onto the 0 - 50 Hz
374 band back to the 50 - 100 Hz band, resulting in an effective 200 Hz sampling frequency. If data
375 from both the VBB (recording 0 - 50 Hz) and SP instrument (recording 50 - 100 Hz) are
376 combined, a bandwidth from 0 to approximately 100 Hz can be covered. For technical reasons,

377 the FIR filters must have a DC gain of 1. Therefore, the FIR filter designed to record the 50 –
378 100 Hz band needs to exclude frequencies close to 100 Hz and in practice ranges from 56 to
379 87 Hz (-3dB), resulting in an effective bandwidth when combining both VBB and SP from 0 –
380 87 Hz with a notch at 50 Hz.

381 A second approach can be applied to repetitive signals with known characteristics, for which
382 significant constraints apply. It is possible to set up inversion schemes to recover information
383 that is aliased even by a few orders, thereby extending the recording bandwidth significantly
384 beyond 50 Hz. Replacing the nominal FIR filter of stage 1 by a single spike will lead to a filter
385 passing all frequencies (Sollberger et al., 2020). Subsequent down-sampling will result in the
386 information being aliased up to several orders. The original signals can be reconstructed by
387 making use of the fact that the HP³ hammering waveform data are characterized by a high
388 number of similar signals generated by each mole hit. Additionally, the hammering is not
389 synchronized with the seismic data sampling so that over the repetitions of the signal the samples
390 spread randomly over time, and this allows recovering the full information content up to a
391 sample rate of 500 Hz (Sollberger et al., 2020). The FIR filter coefficients are implemented in
392 the AC as signed 32-bit integer numbers, followed by a scaling of 2^{-32} . The spike filter is realized
393 by setting all coefficients to zero except one that is set to the maximum value resulting in a filter
394 with a gain of $(2^{31} - 1)/(2^{32}) \approx 0.5$. Hence, the data acquired while this filter is applied need to be
395 multiplied by a factor of 2 before the usual conversion from digital counts to volts is applied,
396 which results in the loss of 1 bit of resolution (the nominal resolution is 24 bits).

397 [Health Monitoring and Trend Analysis](#)

398 Forty-seven housekeeping acquisition channels and numerous status and error flags of E-Box as
399 well as information gathered by the lander provide information about the health of the instrument
400 and especially of the E-Box. If an anomaly occurs, this information can be used to identify and

401 analyze the problem in order to decide on the corrective action necessary, such as changing the
402 configuration or turning off a sub-system. In addition, by monitoring the health information,
403 adverse trends can be detected before a problem or a defect develops.

404 The health monitoring gives confidence that the instrument electronics are functioning well. The
405 actual health check system comprises nine current measurements, thirteen voltage measurements,
406 twenty-three temperature measurements, the position measurements of the SP sensors, an
407 analysis of the clock drift, and the evaluation of sixteen error flags and fourteen status flags.

408 The monitoring system uses state dependent limits, i.e., the limits are set depending on the
409 configuration of the instrument. This allows setting narrower limit bands and provides in
410 addition a check whether the configuration is applied as expected. It significantly reduces the
411 probability of missing anomalous behavior. The configuration of the instrument is determined
412 from the status flags that are returned as part of the health check data.

413 *Trend Analysis*

414 Trend analyses are performed to analyze the long-term stability of the E-Box. It uses a special
415 version of the health check that shows data from several days at the beginning of the period and
416 several days at the end of the period. This facilitates spotting changes in both the average and
417 spread for the parameters analyzed. Changes in the parameter values due to different
418 configurations that are applied during the reporting interval are taken into account. So far, two
419 reports have been created during the operation on Mars, one for the period from 2019-03-11 to
420 2019-10-15, and the second for the period from 2019-10-14 to 2020-10-05. The results can be
421 summarized as follows.

422 *Voltages and Currents:* The configuration changes that are relevant for the E-box voltages and
423 currents during both periods were the switching on and off of the SA heating. The heating was
424 switched on on 2019-05-18. As expected, the current of the + 7V supply increased with the

425 additional heating current. The heating was switched off on 2020-07-18, which reduced the
426 current again to its initial value. No significant change over time was observed for any other of
427 the currents and voltages.

428 *Digital status / error flags:* For the status and error flags, a trend analysis is not applicable. The
429 analysis of the error and status flags in the full reports showed that no error flags were triggered
430 in either of the reported periods. This means that no over-currents have occurred that would have
431 resulted in sub-systems being switched off. No samples were marked invalid for any reason other
432 than overflow in one of the FIR stages, which can also occur during FIR filter settling if a
433 channel is activated. Furthermore, no adverse radiation effects on the operational amplifiers used
434 for the conditioning of the seismic sensor signals were encountered. There was no radiation
435 related disruption in the ADC, which is detected and flagged accordingly by the ADC controller,
436 and thus its synchronization and calibration was established and retained throughout the active
437 period.

438 *Memory data retention:* Only few single-bit errors occurred in the FLASH memory within both
439 periods. The FLASH controller corrects these errors, i.e., they do not result in loss of scientific
440 data. The frequency at which these errors have occurred since landing on Mars is at the expected
441 rate and not increasing. No double-bit errors, which cannot be corrected by the FLASH
442 controller, have occurred in the FLASH memory.

443 The FIR coefficients were always read before the FIR filters were updated or reconfigured and
444 each time the read coefficients were identical to those previously programmed. Thus, there was
445 no data retention problem for the FIR coefficients.

446 *LOBT drift versus SCLK:* Figure 11 shows the LOBT drift w.r.t. the SCLK in parts per million
447 for the last reporting period. No significant difference over time is observed, although the
448 negative peaks seem to be more pronounced in the last set of days. This difference correlates

449 with the temperature of the crystal used for the LOBT. The frequency of this crystal is maximum
450 at 0 °C and thus decreases when the temperature is lower. The temperature's diurnal cycle stays
451 above -15 °C for the first two sets of days, but has minima as low as -20 °C in the last set of
452 days. These lower temperatures explain the more pronounced minima in the last set of days.
453 The maximum drift of the LOBT w.r.t SCLK is around 3.5 ppm in both reporting periods. No
454 significant change over time could be observed. The limits shown in the plot take into account
455 the entire temperature range in which the E-Box can operate, i.e., from -35 °C to +50 °C.
456 *LVL-MDE communication:* The full reports have shown that communication with the LVL-MDE
457 was always successful in the reported periods. This can be confirmed by the acknowledge
458 messages received from the LVL-MDE.
459 *Summary:* In both periods, i.e., during the entire scientific operation on Mars, no anomaly or
460 adverse trend was found in the E-Box.

461

462 1-Hz Mode (Tick-noise)

463 The seismic data acquired by the SEIS instrument show a very small but constant 1 Hz signal
464 with its higher harmonic modes (subsequently denoted as “tick-noise”) as an artefact on all the
465 VBB and SP velocity channels. The amplitude of the tick-noise is of order up to fifty μV_{rms} at
466 the various acquisition system inputs (referring to a full-scale of ± 12.5 V for SP and ± 25 V for
467 VBB). The tick-noise is produced by cross-coupling from switching signals to the sensitive
468 sensor lines that carry the seismic signal, which are routed in parallel through the sensor
469 feedback boards and the 3-meter-long tether down to the sensor assembly. The aggressor signals
470 belong to temperature measurements that are driven by the AC. Currents are being sent through
471 various thermistors in the VBB sensors and their front-end electronics to measure the resulting
472 voltages representing the temperatures. These measurements are cycled through the thermistors,

473 i.e., the signals are switched to each of the thermistors one after the other, every second. This on-
474 off current switching produces transients on the sensor lines at a 1 s repetition rate, resulting in
475 the observed tick-noise. A detailed investigation on the flight spare acquisition and control
476 electronics confirmed that the shapes of the tick-noise could be traced back to the switching
477 instants of the different temperature measurement channels. The tick-noise is most evident
478 during periods of low seismic noise and appears as peaks in the frequency spectrum or as
479 horizontal lines in spectrograms. The tick noise is also prominent in spectrum density charts of
480 longer measurements, where the frequency bins become very narrow, because all its energy is
481 concentrated in a few bins. Examples of tick-noise are shown in Figure 12 and discussed in more
482 detail in the following section.

483 *Investigation and characterization*

484 From the beginning of operations on Mars, the tick-noise was monitored as one of the routine
485 health-check tasks of the SEIS instrument. First on a weekly basis, then every month, the VBB
486 and SP velocity signals are stacked and the amplitude spectra calculated. Then they are manually
487 compared with previous stacks. The objective is to identify, over long term, any instability or
488 continuing trend of tick-noise's amplitude or shape. The following information summarizes the
489 findings so far.

490 In Figure 12 we see the amplitude spectra and in Figure 13 the stacked waveforms of the SEIS
491 velocity channels, recorded in 2019 and 2020 with a 20 Hz sampling rate and configured in high
492 gain, the most common configuration for continuous acquisition on Mars. The left side of
493 Figure 12 shows frequency spectra of the recordings of the three SP channels over 24 hours. The
494 rms (root-mean-square) amplitudes of the tick-noise, calculated from the samples of the stacked
495 signal, vary from channel to channel in the range of 3.9 to 7.5 μV , at a SP full-scale range of
496 $\pm 12.5\text{ V}$.

497 Figure 13 left side shows the tick-noise shapes resulting from stacking the signals of SP
498 recordings on 2019-07-22, 2020-01-03 and 2020-08-28. The stacked signal is always 1 second
499 long, i.e., the number of samples in the stack equals the sampling rate. Note that the peak
500 amplitudes do not change significantly over one year's period between the different recordings.
501 The shapes and amplitudes of SP1 and SP3 are rather invariant over time. The SP2 has a much
502 smaller peak and thus shows larger variation due to the presence of the overall-noise.
503 The amplitude spectrum charts in Figure 12 right side show the VBB channels, recorded on
504 2020-07-04 over 24 hours. The rms amplitudes of the tick-noise vary from channel to channel
505 from $7.5 \mu\text{V}_{\text{rms}}$ up to $49 \mu\text{V}_{\text{rms}}$, the latter due to the significantly larger peak on VBB2. The VBB
506 full-scale range is $\pm 25 \text{ V}$.

507 Figure 13 right side shows stacked VBB waveforms from 2019-06-04, 2020-01-03 and
508 2020-07-04. As for the SP channels, the peak amplitudes do not change significantly over one
509 year's period between the different recordings. The shape and amplitude of VBB2 is almost
510 identical. VBB1 and VBB3 have no distinct peak and show some degree of shape variability, as
511 the signal is very small w.r.t. the overall noise.

512 The VBB channels configured in low gain are rarely used and only for special purposes.
513 Therefore, there are only short records available. To assess how the tick noise affects this
514 configuration, waveforms for all three VBB channels were recorded for 40 minutes on
515 January 19, 2020. No 1-Hz peaks are visible in the spectra of VBB1 and VBB2 because they fall
516 below the noise floor of the sensors. VBB2 shows a peak at 1 Hz, of which the rms amplitude is
517 $17.6 \mu\text{V}_{\text{rms}}$, thus roughly a factor of three smaller than the $49.2 \mu\text{V}_{\text{rms}}$ of VBB2 in high gain.
518 This reflects the gain difference between high and low gain (see P. Lognonné, 2019) and
519 indicates that the crosstalk injection point is in front of the gain stage. The gain selection is part
520 of the velocity signal output amplifier of the VBB sensor feedback electronics and thus just in

521 front of the acquisition electronics. In the remaining VBB channel configuration modes, i.e.,
522 VBB engineering (ENG) at high and low gain, and SP low gain, the tick-noise is not visible due
523 to the higher sensor noise floor.

524 In the commissioning phase, the tick-noise appeared as well with a frequency of 0.1 Hz when the
525 temperature measurements were configured to run at a rate of 10 seconds. The effect and root
526 cause is the same as described above. The project decided that this configuration should no
527 longer be used for the science operation of the instrument.

528 *Tick-noise removal*

529 We suggest removing the tick-noise by subtracting the repetitive 1 Hz signal from the recorded
530 waveform in the time domain. In a first step, we determine the tick-noise waveform by stacking
531 consecutive 1-second chunks from the continuous waveform (i.e., the number of samples per
532 chunk equals the sampling rate). Through this stacking process, the random noise is averaged
533 and thus reduced while the periodic tick-noise is averaged to its amplitude. The result is a
534 waveform of 1 second length, which contains the disturbing tick-noise waveform (see Figure
535 13).

536 The stacking process can be expressed in following equation:

537 7)

$$538 \quad \text{stackSample}(i) = \frac{\sum_{m=0}^{n-1} \text{sample}(t + \text{sampleRate} * m)}{n}, n = 1 \dots \text{number of stacks}$$

539 8)

$$540 \quad \text{number of stacks} = \frac{\text{waveform in seconds}}{\text{sample rate}}$$

541 9)

$$542 \quad \text{Number of samples in stacked waveform} = \text{sampleRate}$$

543 The longer the waveform we are processing, the better the averaging of the random noise and the
544 cleaner the shape of the tick-noise we obtain.

545 In a second step, the offset (i.e., the mean of the samples) is removed from the stacked
546 waveform, as it is not a part of the disturbing signal.
547 In a third step, this tick-noise waveform is subtracted from the continuous waveform second by
548 second in exact phase. After subtraction, the resulting waveform is tick-noise free.

549 The waveform correction becomes:

550 10)

551 $corrSample(i) = sample(i) - stackSample(i - sampleRate * m), for m = 0 \dots n - 1$

552 To achieve a successful removal of the tick-noise, one must take into account the following
553 considerations:

- 554 a) Use continuous waveforms without gaps
- 555 b) Subtract exactly in phase, i.e., subtract the stacked waveform from the same 1 second
556 long chunks that were used in the stacking process
- 557 c) The quality of the tick-noise removal depends on the averaging process. Although the
558 suggested tick-noise removal works well with records as short as 20 minutes, longer
559 waveforms are providing improved results

560 The result of the tick-noise removal works well for most waveforms, including waveforms with
561 sampling rates of 100 Hz. However, the removal may not work satisfactory on shorter
562 waveforms with large drift and/or numerous glitches (Scholz et al., 2020). The stacked
563 waveforms will not be accurate and therefore the tick-noise removal becomes insufficient.
564 Running the removal process on a strongly drifting signal without high-pass filtering results in a
565 waveform with only slightly reduced tick-noise. Filtering of the waveform before stacking, for
566 example with a first-order high-pass filter with a corner frequency at 0.1 Hz, leads to an
567 improved result.

568 Numerous glitches and strongly varying noise amplitudes prevent the waveform from being
569 averaged properly, making the correction imperfect. A significant improvement can be achieved
570 by using only those data chunks for the stacking process that contain no glitches or only glitches
571 with small amplitudes. This is implemented by calculating the variance of each 1-second chunk
572 and comparing it to a defined threshold value. The threshold has to be found experimentally. In
573 the example in Figure 14, a variance threshold of 10^{+4} was chosen to obtain a more accurate peak
574 shape (chart on the right hand side). Approximately 11% of 2880 data chunks exceeded the
575 threshold and were not used for the stacking process.

576 Figure 15 shows the resulting waveform with the removed tick-noise. Re-stacking an already
577 "cleaned up" waveform reveals remaining tick noise with an RMS amplitude less than 1 count.

578 This tick-noise residual can be further reduced by applying a dither, i.e., by adding a random
579 fraction of a count to each sample, before writing to the mini seed file. For example, applying a
580 dither of ± 0.5 count (peak to peak) to the waveform in Figure 15 reduces the remaining tick-
581 noise rms amplitude from 0.29 counts to 0.0073 counts.

582 Alternative approaches for removing the tick noise could be used, for example, a method in the
583 frequency domain could replace the spectral amplitudes at the peaks with the mean of immediate
584 neighboring frequency bands.

585

586 Conclusions

587 Electronics development for planetary space projects is challenging. The enormous vibration
588 imposed during launch and the large shocks while landing on the planet mechanically stress the
589 electronics assembly. The performance must be maintained despite the large temperature
590 variations during operations. The space radiation environment outside the protective
591 magnetosphere of Earth can have damaging effects on the electronics components. Limited

592 power available for planetary missions requires careful balancing and tradeoff between low
593 power design and performance. In order to ensure the successful operation, the requirements
594 with respect to the environment in which the electronics has to perform and sustain are therefore
595 very stringent. The equipment is thoroughly tested before it is accepted for the mission, using
596 temperature ranges that extend well beyond those expected during the real operation. The design
597 must take into account the limited choice of electronics components that are sufficiently thermo-
598 mechanically robust and radiation tolerant. Compromises were made, such as accepting an
599 increased noise at higher frequencies by selecting the 24-bit ADC for the acquisition that in turn
600 has the required radiation tolerance, which was already proven in flight prior to this mission.
601 SEIS electronics was successfully commissioned and has now been operating for more than two
602 years on Mars without any anomalies, acquiring seismic data with a resolution and a dynamic
603 range that is unprecedented in planetary seismology.
604 The described tick-noise artefact is an unwanted signal that was discovered in the integration
605 phase of the development process, too late to take remedial action. The cause is not a problem of
606 a specific point in the electronics, but rather a problem related to the large instrument layout
607 (acquisition electronics – 3m-tether – sensor assembly). Fortunately, the tick-noise is stable and
608 this paper proposes a method that shows its successful removal by post-processing the data.

609

610 [Glossary](#)

| | | |
|-----|------|-------------------------------------|
| 611 | AC | Acquisition and Control electronics |
| 612 | ACQ | Acquisition Electronics board |
| 613 | ADC | Analog-to-Digital Converter |
| 614 | APSS | Auxiliary Payload Sensor Suite |
| 615 | C&DH | Command and Data Handling unit |

| | | |
|-----|-----------------|---|
| 616 | CTL | Control Electronics board |
| 617 | DC | Power Distribution and Conditioning Electronics board |
| 618 | DMM | Digital Multi-Meter |
| 619 | E-Box | Electronics Box |
| 620 | FIR | Finite Impulse Response filter |
| 621 | FPGA | Field Programmable Gate Array |
| 622 | FLASH | non-volatile memory |
| 623 | FM | Flight Model |
| 624 | HP ³ | Heat Flow and Physical Properties Package |
| 625 | INL | Integral Non-Linearity |
| 626 | InSight | Interior exploration using Seismic Investigations, Geodesy and Heat Transport |
| 627 | LOBT | Local On-Board Time |
| 628 | LVL | Leveling Structure |
| 629 | LVL-MDE | Leveling Motor Drive Electronics |
| 630 | PDDU | Power Distribution & Drive Unit |
| 631 | PDS | Planetary Data System |
| 632 | RISE | Rotation and Interior Structure Experiment |
| 633 | RWEB | Remote Warm Enclosure Box |
| 634 | SCIT | Scientific Temperature |
| 635 | SCLK | Spacecraft Clock |
| 636 | SEIS | Seismic Experiment for Interior Structure |
| 637 | SA | Sensor Assembly |
| 638 | SP | Short Period sensors |
| 639 | SP-FB | SP Feedback board |

640 UTC Universal Time Coordinated
641 VBB Very-Broadband sensors
642 VBB-FB VBB Feedback board
643 WEB Warm Electronics Box
644 WTS Wind and Thermal Shield

645

646 *Data and Resources – see detailed information below*

647 *Tick-Noise Removal Implementation in MATLAB and PYTHON code*

648 The function TICKREM is provided in MATLAB and PYTHON code, available for download in
649 the electronic supplement to this article. It reads a mini seed file, corrects it and writes another
650 mini seed file. For mini seed read and write, the MATLAB version calls the functions
651 RDMSEED and MKMSEED, downloadable from MathWorks web site

652 [[https://ch.mathworks.com/matlabcentral/fileexchange/28803-rdmseed-and-mkmseed-read-and-](https://ch.mathworks.com/matlabcentral/fileexchange/28803-rdmseed-and-mkmseed-read-and-write-miniseed-files)
653 [write-miniseed-files](https://ch.mathworks.com/matlabcentral/fileexchange/28803-rdmseed-and-mkmseed-read-and-write-miniseed-files)].

654 The read and write file names and corresponding directory paths can be specified in the
655 arguments. The stacking and the removal process is performed in double precision floating point,
656 but rounded to integer before writing to the mini seed file. The result is written to the same
657 SEED compression format as read (Note: only Steim1 and Steim2 are implemented).

658 There are three other arguments that control the correction function. The argument [hp_filt] sets
659 the corner frequency of the first-order high-pass filter in Hz. The value [0] will switch-off the
660 filter, the recommended default value is [0.1] Hz. The argument [var_threshold] defines the
661 threshold that defines up to which variance level the waveform chunk is used for the stacking
662 process. Chunks with a variance level higher than [var_threshold] are disregarded (refer to
663 section [Tick-noise removal]). The recommended default value is [10^{+05}]. Finally, the argument

664 [dither], which further reduces the residual of the tick-noise by applying and thus randomizing
665 the waveform. The recommended value is [1.0], which corresponds to a dither of ± 0.5 count. The
666 value set to zero will switch-off the dither.

667 The default values are suitable for most waveforms.

668

669 The InSight mission raw and calibrated data sets are available via NASA's Planetary Data
670 System (PDS; National Aeronautics and Space Administration Planetary
671 Data System, <https://pds.nasa.gov/>; InSight Mars SEIS Data Service (2019)). Data are delivered
672 to the PDS according to the InSight Data Management Plan available in the InSight PDS archive.
673 All datasets can be accessed at <https://pds-geosciences.wustl.edu/missions/insight/index.html>.

674

675 *Acknowledgments*

676 We acknowledge NASA, CNES and its partner agencies and institutions (UKSA, SSO,
677 DLR, JPL, IPGP-CNRS, ETHZ, IC and MPS-MPG) and the flight operations team at JPL,
678 SISMOC, MSDS, IRIS-DMC and PDS for providing SEIS data. The Swiss co-authors were
679 jointly funded by (1) the Swiss National Science Foundation and French Agence
680 Nationale de la Recherche (SNF-ANR project 157133 'Seismology on Mars'), (2) the
681 Swiss National Science Foundation (SNF project 172508 'Mapping the internal structure of
682 Mars'), (3) the Swiss State Secretariat for Education, Research and Innovation, (4) ETH research
683 grant ETH-06 17-2. This is InSight contribution number 208.

684

685 *References*

686 Banerdt, W. B., S. Smrekar, D. Banfield, D. Giardini, M. Golombek, C. Johnson, P. Lognonné,
687 A. Spiga, T. Spohn, C. Perrin, S. Stähler, D. Antonangeli, S. Asmar, C. Beghein, N.

688 Bowles, E. Bozdag, P. Chi, U. Christensen, J. Clinton, G. Collins, I. Daubar, V. Dehant,
689 M. Drilleau, M. Fillingim, B. Folkner, R. Garcia, J. Garvin, J. Grant, M. Grott, J.
690 Grygorczuk, T. Hudson, J. Irving, G. Kargl, T. Kawamura, S. Kedar, S. King, B.
691 Knapmeyer-Endrun, M. Knapmeyer, M. Lemmon, R. Lorenz, J. Maki, L. Margerin, S.
692 McLennan, C. Michaut, D. Mimoun, A. Mittelholz, A. Mocquet, P. Morgan, N. Mueller,
693 S. N. Murdoch, Nagihara, C. Newman, F. Nimmo, M. Panning, T. Pike, A.-C. Plesa, S.
694 Rodriguez, J.-A. Rodriguez-Manfredi, C. Russell, N. Schmerr, M. Siegler, S. Stanley, E.
695 Stutzmann, N. Teanby, J. Tromp, M. van Driel, N. Warner, R. Weber, and M. Wieczorek,
696 Initial results from the InSight mission on Mars. *Nat. Geosci.* 13, 183–189 (2020).
697 <https://doi.org/10.1038/s41561-020-0544-y>
698
699 Banfield, D., J.A. Rodriguez-Manfredi, C.T. Russell, K.M. Rowe, D. Leneman, H.R. Lai, P.R.
700 Cruce, J.D. Means, C.L. Johnson, S.P. Joy, P.J. Chi, I.G. Mikellides, S. Carpenter, S.
701 Navarro, E. Sebastian, J. Gomez-Elvira, J. Torres, L. Mora, V. Peinado, A. Lepinette, K.
702 Hurst, P. Lognonné, S.E. Smrekar and W.B. Banerdt, InSight Auxiliary Payload Sensor
703 Suite (APSS). *Space Sci. Rev.* (2018). <https://doi.org/10.1007/s11214-018-0570-x>
704
705 Brinkman, N., C. Schmelzbach, D. Sollberger, M. van Driel, J. ten Pierick, J. O. A. Robertsson,
706 F. Andersson, S. Kedar, M. Grott, T. Hudson, W. B. Banerdt, L. Fayon, A. Horleston, K.
707 Hurst, A. Kiely, B. Knapmeyer-Endrun, C. Krause, P. Lognonné, W. T. Pike, S. Stähler,
708 T. Spohn, and N. Teanby (2019), The first active-seismic experiment on Mars to
709 characterize the shallow subsurface structure at the InSight landing site, SEG Technical
710 Program Expanded Abstracts 2019, 4756–4760, doi:10.1190/segam2019-3215661.1
711

712 S. Ceylan, J.F. Clinton, D. Giardini, M. Böse, C. Charalambous, M. van Driel, A. Horleston,
713 T. Kawamura, A. Khan, G. Orhand-Mainsant, JR. Scholz, S. Stähler, F. Euchner,
714 W.B. Banerdt, P. Lognonné, D. Banfield, E. Beucler, R.F. Garcia, S. Kedar,
715 M.P. Panning, W.T. Pike, S.E. Smrekar, A. Spiga, N.L. Dahmen, K. Hurst, A.E. Stott,
716 R. D. Lorenz, M. Schimmel, E. Stutzmann, J. ten Pierick, V. Conejero, C. Pardo,
717 C. Perrin, (2020), Companion guide to the Marsquake catalog from InSight, sols 0–478:
718 Data content and non-seismic events, Physics of the Earth and Planetary Interiors.
719 <https://doi.org/10.1016/j.pepi.2020.106597>
720
721 Folkner, W.M., V. Dehant, S. Le Maistre, M. Yseboodt, A. Rivoldini, T. Van Hoolst, S.W.
722 Asmar, M.P. Golombek, The Rotation and Interior Structure Experiment on the InSight
723 Mission to Mars, Space Sci. Rev., 214:100, 2018. doi:10.1007/s11214-018-0530-5
724
725 Golombek, M., M. Grott, G. Kargl, J. Andrade, J. Marshall, N. Warner, N.A. Teanby, V. Ansan,
726 E. Hauber, J. Voigt, R. Lichtenheldt, B. Knapmeyer-Endrun, I.J. Daubar, D. Kipp, N.
727 Muller, P. Lognonné, C. Schmelzbach, D. Banfield, A. Trebi-Ollennu, J. Maki, S. Kedar,
728 D. Mimoun, N. Murdoch, S. Piqueux, P. Delage, W.T. Pike, C. Charalambous, R.
729 Lorenz, L. Fayon, A. Lucas, S. Rodriguez, P. Morgan, A. Spiga, M. Panning, T. Spohn,
730 S. Smrekar, T. Gudkova, R. Garcia, D. Giardini, U. Christensen, T. Nicollier, D.
731 Sollberger, J. Robertsson, K. Ali, B. Kenda and W. B. Banerdt (2018), Geology and
732 Physical Properties Investigations by the InSight Lander, Space Science Review, 214(5),
733 84, 10.1007/s11214-018-0512-7.
734

735 Kedar, S., Andrade, J., Banerdt, B., Delage, P., Golombek, M., Grott, M., T. Hudson, A. Kiely,
736 M. Knapmeyer, B. Knapmeyer-Endrun, C. Krause, T. Kawamura, P. Lognonné,
737 W.T. Pike, Y. Ruan, T. Spohn, N. Teanby, J. Tromp and J. Wookey (2017). Analysis of
738 Regolith Properties Using Seismic Signals Generated by InSight's HP³ Penetrator. *Space*
739 *Science Reviews*, 211, 315–337. doi: 10.1007/s11214-017-0391-3
740
741 P. Lognonné, W.B. Banerdt, D. Giardini, W.T. Pike, U. Christensen, P. Laudet, S. de Raucourt,
742 P. Zweifel, S. Calcutt, M. Bierwirth, K.J. Hurst, F. Ijpelaan, J.W. Umland, R. Llorca-
743 Cejudo, S.A. Larson, R.F. Garcia, S. Kedar, B. Knapmeyer-Endrun, D. Mimoun, A.
744 Mocquet, M.P. Panning, R.C. Weber, A. Sylvestre-Baron, G. Pont, N. Verdier, L.
745 Kerjean, L.J. Facto, V. Gharakanian, J.E. Feldman, T.L. Hoffman, D.B. Klein, K. Klein,
746 N.P. Onufer, J. Paredes-Garcia, M.P. Petkov, J.R. Willis, S.E. Smrekar, M. Drilleau, T.
747 Gabsi, T. Nebut, O. Robert, S. Tillier, C. Moreau, M. Parise, G. Aveni, S. Ben Charef, Y.
748 Bennour, T. Camus, P.A. Dandonneau, C. Desfoux, B. Lecomte, O. Pot, P. Revuz,
749 D. Mance, J. tenPierick, N.E. Bowles, C. Charalambous, A.K. Delahunty, J. Hurley, R.
750 Irshad, H. Liu, A.G. Mukherjee, I.M. Standley, A.E. Stott, J. Temple, T. Warren, M.
751 Eberhardt, A. Kramer, W. Kühne, E.-P. Miettinen, M. Monecke, C. Aicardi, M. André, J.
752 Baroukh, A. Borrien, A. Bouisset, P. Boutte, K. Brethomé, C. Brysbaert, T. Carlier, M.
753 Deleuze, J.M. Desmarres, D. Dilhan, C. Doucet, D. Faye, N. Faye-Refalo, R. Gonzalez,
754 C. Imbert, C. Larigauderie, E. Locatelli, L. Luno, J.-R. Meyer, F. Mialhe, J.M. Mouret,
755 M. Nonon, Y. Pahn, A. Paillet, P. Pasquier, G. Perez, R. Perez, L. Perrin, B. Pouilloux, A.
756 Rosak, I. Savin de Larclause, J. Sicre, M. Sodki, N. Toulemont, B. Vella, C. Yana, F.
757 Alibay, O.M. Avalos, M.A. Balzer, P. Bhandari, E. Blanco, B.D. Bone, J.C. Bousman, P.
758 Bruneau, F.J. Calef, R.J. Calvet, S.A. D'Agostino, G. de los Santos, R.G. Deen, R.W.

759 Denise, J. Ervin, N.W. Ferraro, H.E. Gengl, F. Grinblat, D. Hernandez, M. Hetzel, M.E.
760 Johnson, L. Khachikyan, J.Y. Lin, S.M. Madzunkov, S.L. Marshall, I.G. Mikellides, E.A.
761 Miller, W. Raff, J.E. Singer, C.M. Sunday, J.F. Villalvazo, M.C. Wallace, D. Banfield,
762 J.A. Rodriguez-Manfredi, C.T. Russell, A. Trebi-Ollennu, J.N. Maki, E. Beucler, M.
763 Böse, C. Bonjour, J.L. Berenguer, S. Ceylan, J. Clinton, V. Conejero, I. Daubar, V.
764 Dehant, P. Delage, F. Euchner, I. Estève, L. Fayon, L. Ferraioli, C.L. Johnson, J.
765 Gagnepain-Beyneix, M. Golombek, A. Khan, T. Kawamura, B. Kenda, P. Labrot, N.
766 Murdoch, C. Pardo, C. Perrin, L. Pou, A. Sauron, D. Savoie, S. Stähler, E. Stutzmann,
767 N.A. Teanby, J. Tromp, M. van Driel, M. Wieczorek, R. Widmer-Schmidrig, J. Wookey
768 (2019). SEIS: Insight's seismic experiment for internal structure of Mars.
769 <https://doi.org/10.1007/s11214-018-0574-6>
770
771 Lognonné, P., W. B. Banerdt, W. T. Pike, D. Giardini, U. Christensen, R. F. Garcia, T.
772 Kawamura, S. Kedar, B. Knapmeyer-Endrun, L. Margerin, F. Nimmo, M. Panning, B.
773 Tazuin, J. R. Scholz, D. Antonangeli, S. Barkaoui, E. Beucler, F. Bissig, N. Brinkman,
774 M. Calvet, S. Ceylan, C. Charalambous, P. Davis, M. van Driel, M. Drilleau, L. Fayon,
775 R. Joshi, B. Kenda, A. Khan, M. Knapmeyer, V. Lekic, J. McClean, D. Mimoun, N.
776 Murdoch, L. Pan, C. Perrin, B. Pinot, L. Pou, S. Menina, S. Rodriguez, C. Schmelzbach,
777 N. Schmerr, D. Sollberger, A. Spiga, S. Stähler, A. Stott, E. Stutzmann, S. Tharimena, R.
778 Widmer-Schmidrig, F. Andersson, V. Ansan, C. Beghein, M. Böse, E. Bozdog, J. Clinton,
779 I. Daubar, P. Delage, N. Fuji, M. Golombek, M. Grott, A. Horleston, K. Hurst, J. Irving,
780 A. Jacob, J. Knollenberg, S. Krasner, C. Krause, R. Lorenz, C. Michaut, B. Myhill, T.
781 Nissen-Meyer, J. ten Pierick, A.-C. Plesa, C. Quantin-Nataf, J. Robertsson, L. Rochas, M.
782 Schimmel, S. Smrekar, T. Spohn, N. Teanby, J. Tromp, J. Vallade, N. Verdier, C.

783 Vrettos, R. Weber, D. Banfield, E. Barrett, M. Bierwirth, S. Calcutt, N. Compaire, C.
784 Johnson, D. Mance, F. Euchner, L. Kerjean, G. Mainsant, J. A. Rodriguez Manfredi, G.
785 Pont, P. Laudet, T. Nebut, S. de Raucourt, O. Robert, C. Russell, A. Sylvestre-Baron, S.
786 Tillier, T. Warren, M. Wieczorek, C. Yana, P. Zweifel, Constraints on the shallow elastic
787 and anelastic structure of Mars from InSight seismic data. *Nat. Geosci.*, 13, 213–220
788 (2020). <https://doi.org/10.1038/s41561-020-0536-y>
789

790 Scholz, J.- R., R. Widmer-Schmidrig, P. Davis, P. Lognonné, B. Pinot, R. F. Garcia, F. Nimmo,
791 K. Hurst, S. Barkaoui, S. de Raucourt, L. Pou, B. Pinot, N. Compaire, G. Mainsant, A.
792 Cuvier, E. Beucler, M. Bonnin, R. Joshi, E. Stutzmann, M. Schimmel, A. Horleston, M.
793 Böse, S. Ceylan, J. Clinton, M. van Driel, T. Kawamura, A. Khan, S. C. Stähler, D.
794 Giardini, C. Charalambous, A. E. Stott, W. T. Pike, U. Christensen and W. B. Banerdt
795 (2020). Detection, analysis and removal of glitches from InSight’s seismic data from
796 Mars. *Earth and Space Science* 7, e2020EA001317- T.
797 <https://doi.org/10.1029/2020EA001317>
798

799 Spohn, T., M. Grott, S. E. Smrekar, J. Knollenberg, T. L. Hudson, C. Krause, N. Müller. J.
800 Jänchen, A. Börner, T. Wippermann, O. Krömer, R. Lichtenheldt, L. Wisniewski, J.
801 Grygorczuk, M. Fittock, S. Reershemius, T. Spröwitz, E. Kopp, I. Walter, A.-C. Plesa, D.
802 Breuer, P. Morgan, W. B. Banerdt, The Heat Flow and Physical Properties Package (HP³)
803 for the InSight Mission, *Space Sci. Rev.*, 214:96, 2018. [https://doi.org/10.1007/s11214-](https://doi.org/10.1007/s11214-018-0531-4)
804 [018-0531-4](https://doi.org/10.1007/s11214-018-0531-4)
805

806 Sollberger, D., C. Schmelzbach, F. Andersson, J. O. A. Robertsson, S. Kedar, W. B. Banerdt, N.
807 Brinkman, J. Clinton, M. van Driel, R. Garcia, D. Giardini, M. Grott, T. Haag, T. L.
808 Hudson, P. Lognonné, J. ten Pierick, W. T. Pike, T. Spohn, S. Stähler, P. Zweifel, (2020),
809 Reconstruction of temporally aliased seismic signals recorded by the InSight Mars lander,
810 submitted to Earth and Space Science, 10.1002/essoar.10502908.1
811
812 InSight Mars SEIS Data Service. (2019). SEIS raw data, Insight Mission. IPGP, JPL, CNES,
813 ETHZ, ICL, MPS, ISAE-Supaero, LPG, MFSC.
814 https://doi.org/10.18715/SEIS.INSIGHT.XB_2016
815
816 NASA InSight Web Site. Artist's rendering of the Sensor Assembly. Credit: NASA/JPL-
817 Caltech/CNES/IPGP Download on [https://mars.nasa.gov/resources/22107/cutaway-of-](https://mars.nasa.gov/resources/22107/cutaway-of-seis/?site=insight)
818 [seis/?site=insight](https://mars.nasa.gov/resources/22107/cutaway-of-seis/?site=insight)

Full mailing address for each author

| | | | | | | |
|------------|-------------|--|--|-------------------------|----------------------|-------------------|
| W. Bruce | Banerdt | william.b.banerdt@jpl.nasa.gov | Jet Propulsion Laboratory / California Institute of Technology | 4800 Oak Grove Drive | Pasadena, CA 91109 | USA |
| Marco | Bierwirth | bierwirthm@mps.mpg.de | Max-Planck-Institute for Solar System Research, Göttingen | Justus-von-Liebig Weg 3 | D-37077 Göttingen | Germany |
| Savas | Ceylan | savas.ceylan@erdw.ethz.ch | Eidgenössische Technische Hochschule Zürich / Institute of Geophysics | Sonneggstrasse 5 | CH-8092 Zurich | Switzerland |
| John F. | Clinton | jclinton@sed.ethz.ch | Eidgenössische Technische Hochschule Zürich / Swiss Seismological Service | Sonneggstrasse 5 | CH-8092 Zurich | Switzerland |
| Michel | Eberhardt | eberhardt@mps.mpg.de | Max-Planck-Institute for Solar System Research, Göttingen | Justus-von-Liebig Weg 3 | D-37077 Göttingen | Germany |
| Fabian | Euchner | fabian.euchner@sed.ethz.ch | Eidgenössische Technische Hochschule Zürich / Swiss Seismological Service | Sonneggstrasse 5 | CH-8092 Zurich | Switzerland |
| Domenico | Giardini | domenico.giardini@erdw.ethz.ch | Eidgenössische Technische Hochschule Zürich / Institute of Geophysics | Sonneggstrasse 5 | CH-8092 Zurich | Switzerland |
| Thomas | Haag | thomas.haag@erdw.ethz.ch | Eidgenössische Technische Hochschule Zürich / Institute of Geophysics | Sonneggstrasse 5 | CH-8092 Zurich | Switzerland |
| Philippe | Lognonné | lognonne@ipgp.fr | Institut de Physique du Globe de Paris | 35 rue Hélène Brion | 75205 Paris Cedex 13 | France |
| Davor | Mance | davor.mance@retired.ethz.ch | Eidgenössische Technische Hochschule Zürich / Institute of Geophysics | Sonneggstrasse 5 | CH-8092 Zurich | Switzerland |
| Tobias | Nicollier | tobias.nicollier@wsl.ch | Eidgenössische Forschungsanstalt WSL | Zürcherstrasse 111 | CH-8903 Birmensdorf | Switzerland |
| William T. | Pike | w.t.pike@ic.ac.uk | Imperial College London | Exhibition Road | London SW7 2AZ | United Kingdom |
| Cedric | Schmelzbach | cedric.schmelzbach@erdw.ethz.ch | Eidgenössische Technische Hochschule Zürich / Institute of Geophysics | Sonneggstrasse 5 | CH-8092 Zurich | Switzerland |
| David | Sollberger | david.sollberger@erdw.ethz.ch | Eidgenössische Technische Hochschule Zürich / Institute of Geophysics | Sonneggstrasse 5 | CH-8092 Zurich | Switzerland |

| | | | | | | |
|--------|-------------|--|--|------------------|----------------|-------------|
| Simon | Stähler | simon.staehler@erdw.ethz.ch | Eidgenössische Technische Hochschule Zürich / Institute of Geophysics | Sonneggstrasse 5 | CH-8092 Zurich | Switzerland |
| Jan | ten Pierick | jan.tenpierick@erdw.ethz.ch | Eidgenössische Technische Hochschule Zürich / Institute of Geophysics | Sonneggstrasse 5 | CH-8092 Zurich | Switzerland |
| Martin | van Driel | vandriel@erdw.ethz.ch | Eidgenössische Technische Hochschule Zürich / Institute of Geophysics | Sonneggstrasse 5 | CH-8092 Zurich | Switzerland |
| Peter | Zweifel | peter.zweifel@retired.ethz.ch | Eidgenössische Technische Hochschule Zürich / Institute of Geophysics | Sonneggstrasse 5 | CH-8092 Zurich | Switzerland |

822 *Tables, with captions above each table*

823

824 *List of Figure Captions*

825 Figure 1 Artist’ rendering showing a cutaway of the SEIS Sensor Assembly (SA) and the Wind
826 and Thermal Shield (WTS). The leveling structure (LVL) was delivered by Max-Planck Solar
827 System Research in Göttingen, Germany (MPS), the VBB sensor by the Institut du Physique du
828 Globe in Paris, France, the SP sensors by Imperial College in London, UK, and the Wind and
829 Thermal Shield (WTS) and tether by Jet Propulsion Laboratory (JPL) in Pasadena, USA. Credit:

830 NASA/JPL-Caltech/CNES/IPGP (NASA InSight Web Site)..... 41

831 Figure 2 SEIS Electronics Box (E-Box) outside view, physical configuration and electrical
832 interconnections. The picture upper left shows the Flight Model (FM) unit, in preparation for the
833 thermal test. Dimensions: 244 mm (height), 170 mm (width), 344 mm (length); weight ~5 kg; E-
834 Box was delivered by ETH Zurich in Switzerland. The exploded view of the E-Box shows the
835 board configuration: three VBB-FB feedback boards (delivered by IPGP); one SP-FB feedback
836 board (delivered by Oxford University); one motor drive electronic board LVL-MDE (delivered
837 by MPS); one ACQ acquisition board (partially duplicated) and two duplicated control
838 electronics boards CTL; two duplicated DC power boards, condition the primary +28 V to all
839 secondary voltages needed by the sub-systems (delivered by ETHZ). Figure credit to Syderal

840 SA, Switzerland, the manufacturer of the E-Box. The Block Diagram (lower part of the figure)
841 shows the interconnections within the SEIS instrument and to the external units Command &
842 Data Handling C&DH, the Power Distribution and Drive Unit PDDU and the Auxiliary Payload
843 Sensor Suite APSS (Banfield, 2018) 42

844 Figure 3 Acquisition chain with the anti-alias filter steps (block diagram on top). The charts
845 show the attenuation of the individual filters (left) and the attenuation combined (right) for the
846 velocity chain at 20 Hz output rate. 43

847 Figure 4 FIR filter stages for the VBB and SP velocity channels (upper diagram) and for the
848 VBB position and scientific temperature (SCIT) channels (lower diagram)..... 44

849 Figure 5 Acquisition Noise Breakdown of VBB velocity channel. (P. Lognonné, 2019)..... 45

850 Figure 6 Noise Performance of VBB channels, compared to the acquisition system noise. VBB
851 position channels (left chart) at a sample rate of 1 Hz; recordings from 2019-10-18 at 20:00 for
852 59 min on Mars and recordings obtained at board level test on 2014-10-04 for 59 min. VBB
853 velocity channels (right chart) at a sample rate of 100 Hz; recordings from 2020-02-04 at 17:52
854 for 15 min on Mars (event and recordings obtained at board level test on 2014-10-16 for 15 min
855 45

856 Figure 7 Noise Performance of SP velocity channels during cruise and on Mars, compared to the
857 acquisition system noise; sample rate = 100 Hz; recordings from 2019-01-12 at 05:10 for 15 min
858 on Mars, from 2018-07-16 at 15:48 for 7 min during cruise, and recordings obtained at board
859 level test on 2014-10-16 for 15 min..... 46

860 Figure 8 Linearity Measurement: Principal configuration (block diagram) and measurement
861 results 47

862 Figure 9 Scientific Temperature (SCIT A) time-series and ASD, measured on a fixed resistor
863 instead of a thermistor. Sampling rate = 1 Hz; 2 h time-series; this measurement has been
864 performed in the final test campaign of E-Box FM before delivery to CNES for SEIS integration.
865 48

866 Figure 10 Sampling strategy to record signals with frequencies up to 100 Hz (simulating a
867 sampling rate of 200 Hz from two separate 100 Hz recordings). (Upper row) The VBB data will

868 be acquired with the standard anti-alias filter (0–50 Hz low-pass filter) when down-sampling the
869 signals digitized at 500 Hz to 100 Hz. (Lower row) The SP data will be filtered with a 50–100
870 Hz band pass filter, which results in the SP data being folded one time. For the reconstruction of
871 the 0–100 Hz bandwidth (corresponding to 200 Hz sampling; see rightmost sketch), the aliased
872 SP data are folded back before adding the VBB and SP data together. Due to the periodicity of
873 the Fourier transform, down-sampling to 100 Hz will cause the signal to be periodically repeated
874 along the frequency axis at a spacing of 100 Hz (so-called aliases). The different filters used for
875 the SP and VBB channels ensure that the aliases do not overlap, so that they can be individually
876 isolated and used for the reconstruction..... 48

877 Figure 11 The drift of the LOBT versus the SCLK in the second reporting period from 2019-10-
878 14 to 2020-10-05..... 49

879 Figure 12 Left side: Amplitude spectra of SP1, SP2 and SP3 channels at high gain and 20 Hz
880 sampling rate; 24 h time-series; start time 2020-08-29 00:00:00 UTC; tick-noise amplitudes
881 calculated from the samples of the stacked signal: SP1= 7.2 μ Vrms, SP2 = 3.9 μ Vrms, SP3 = 7.4
882 μ Vrms. Right side: Amplitude spectra of VBB1, VBB2 and VBB3 channels in high gain and 20
883 Hz data rate; 40 min time-series; start time at 2020-07-04 14:50:00; tick-noise amplitudes
884 calculated from the samples of the stacked signal: VBB1 = 7.5 μ Vrms, VBB2 = 49.2 μ Vrms,
885 VBB3 =14.2 μ Vrms 50

886 Figure 13 Left side: Stacked waveforms for SP1, SP2 and SP3 at high gain and 20 Hz sampling
887 rate; recordings from 2019-07-22 (18 hours), from 2020-01-03 (48 hours) and from 2020-08-28
888 (24 hours). Right side: Stacked waveforms for VBB1, VBB2 and VBB3; recordings from 2019-
889 06-04 (48 hours), 2020-01-03 (48 hours) and 2020-07-04 (48 hours) 51

890 Figure 14 Comparison of the stacked waveform, SP1, recorded on 2019-01-12 at 05:07:26 for 48
891 min, with 100 Hz sample rate, high-pass filter with 0.1 Hz corner frequency; left: all available

892 data is stacked, right: variance level set to 10^{+4} counts; 328 of 2880 1-second chunks were
893 rejected..... 52

894 Figure 15 Corrected SP1 data, high-pass filter with 0.1 Hz corner frequency, accepting waveform
895 chunks for the stacking process only with a variance below variance level 10^{+4} counts, as in
896 Figure 14 on the right side. Data recorded on 2019-01-12 at 05:07:26 for 48 min, with 100 Hz
897 sample rate. 52

898
899 *Figures, with captions below each figure – high resolution figure files are not needed*
900 *for the review process. They will be requested after your paper is accepted for*
901 *publication.*

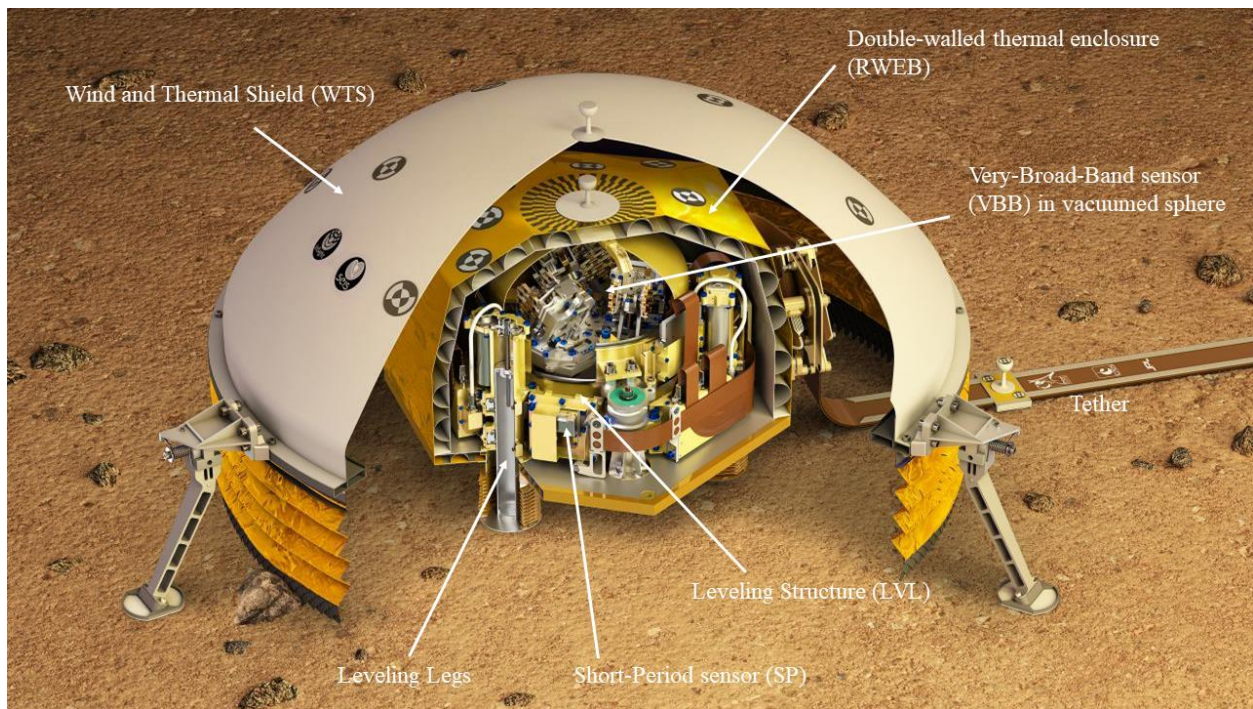

902
903 Figure 1 Artist' rendering showing a cutaway of the SEIS Sensor Assembly (SA) and the Wind and
904 Thermal Shield (WTS). The leveling structure (LVL) was delivered by Max-Planck Solar System Research
905 in Göttingen, Germany (MPS), the VBB sensor by the Institut du Physique du Globe in Paris, France, the
906 SP sensors by Imperial College in London, UK, and the Wind and Thermal Shield (WTS) and tether by Jet
907 Propulsion Laboratory (JPL) in Pasadena, USA. Credit: NASA/JPL-Caltech/CNES/IPGP (NASA InSight
908 Web Site)

909

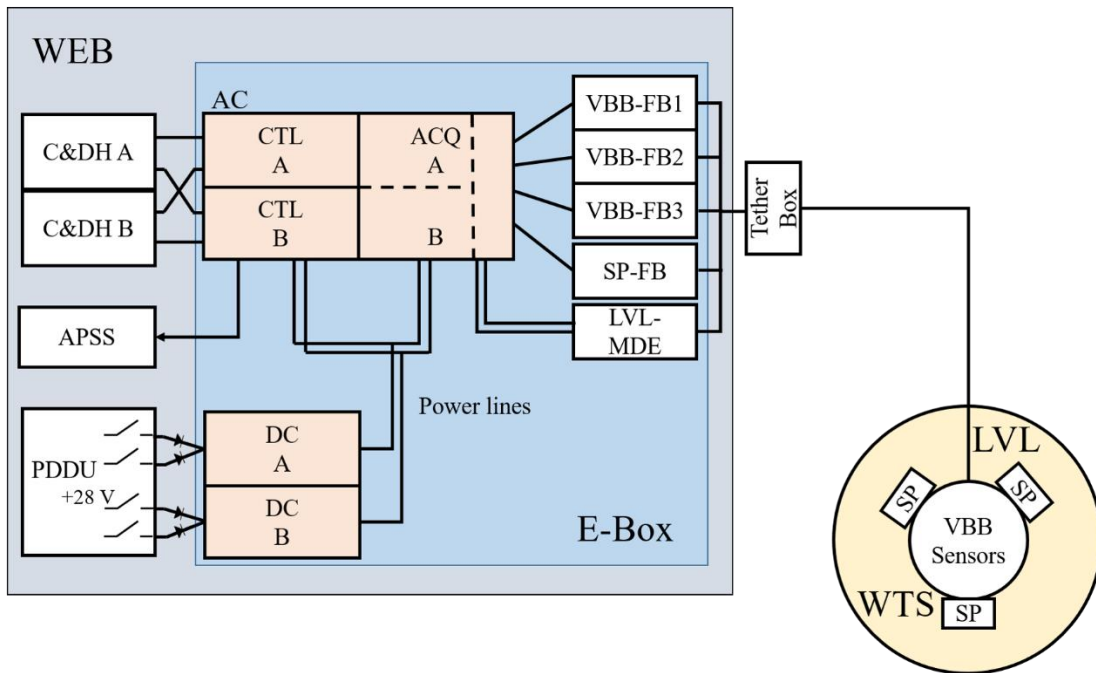
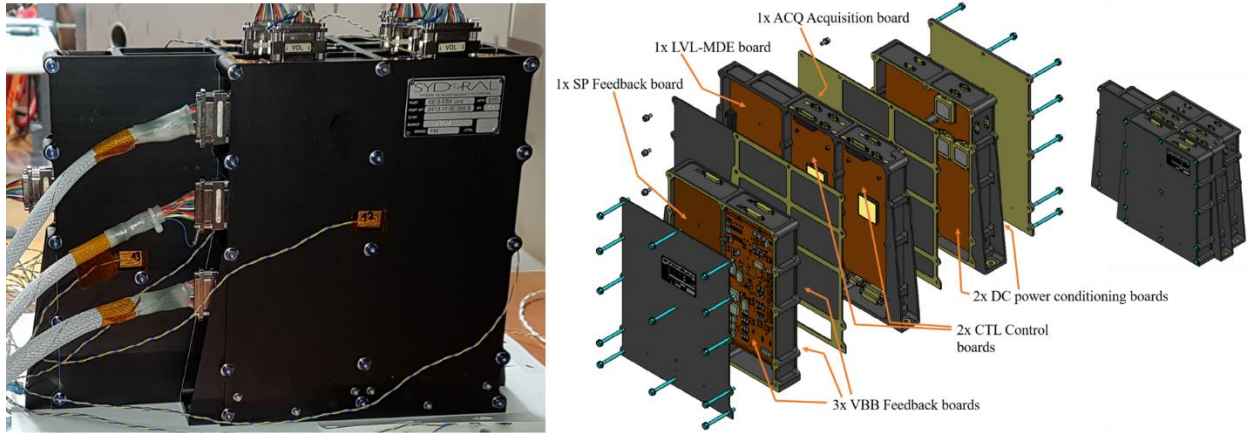

910

911 Figure 2 SEIS Electronics Box (E-Box) outside view, physical configuration and electrical
 912 interconnections. The picture upper left shows the Flight Model (FM) unit, in preparation for the thermal
 913 test. Dimensions: 244 mm (height), 170 mm (width), 344 mm (length); weight ~5 kg; E-Box was delivered
 914 by ETH Zurich in Switzerland. The exploded view of the E-Box shows the board configuration: three
 915 VBB-FB feedback boards (delivered by IPGP); one SP-FB feedback board (delivered by Oxford
 916 University); one motor drive electronic board LVL-MDE (delivered by MPS); one ACQ acquisition board
 917 (partially duplicated) and two duplicated control electronics boards CTL; two duplicated DC power boards,
 918 condition the primary +28 V to all secondary voltages needed by the sub-systems (delivered by ETHZ).
 919 Figure credit to Syderal SA, Switzerland, the manufacturer of the E-Box. The Block Diagram (lower part
 920 of the figure) shows the interconnections within the SEIS instrument and to the external units Command &
 921 Data Handling C&DH, the Power Distribution and Drive Unit PDDU and the Auxiliary Payload Sensor
 922 Suite APSS (Banfield, 2018)

923

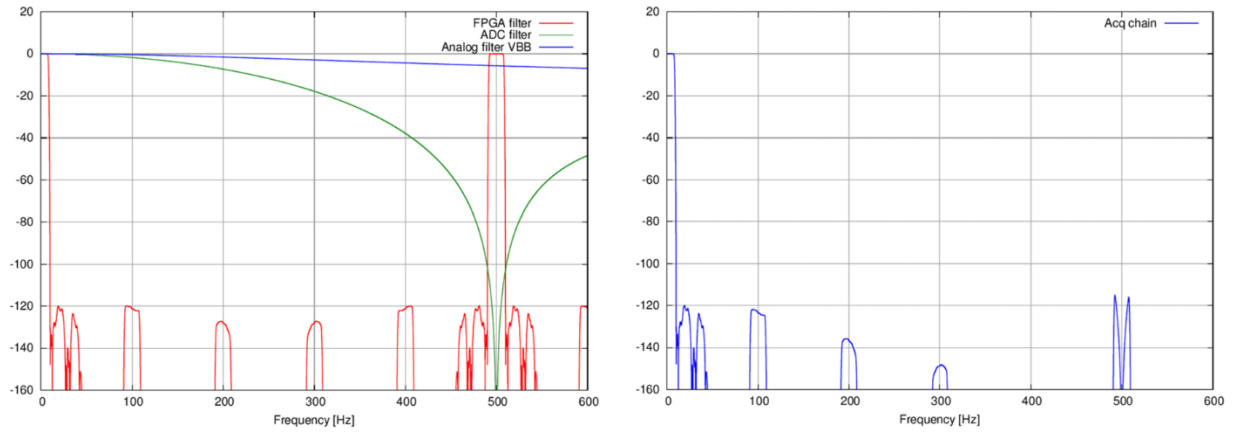
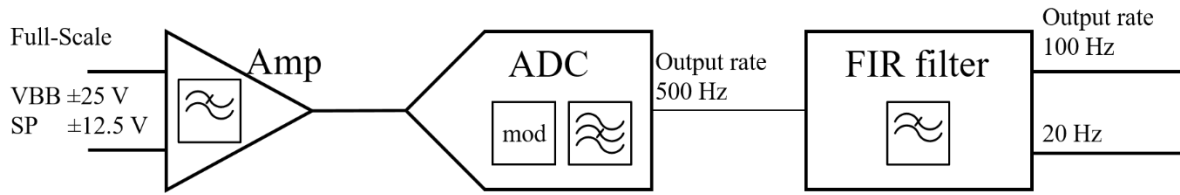

924

925

926

927

Figure 3 Acquisition chain with the anti-alias filter steps (block diagram on top). The charts show the attenuation of the individual filters (left) and the attenuation combined (right) for the velocity chain at 20 Hz output rate.

928

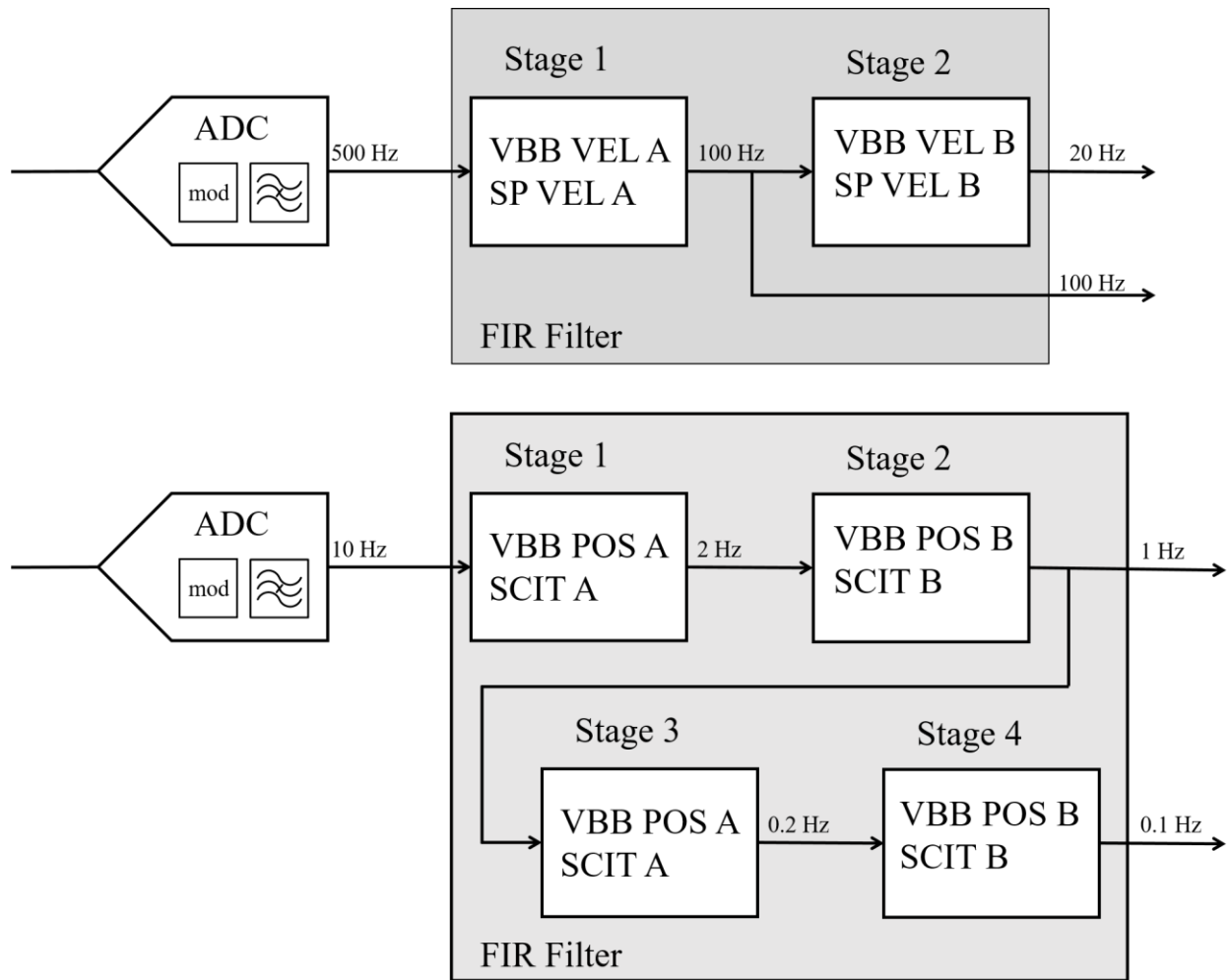

929

930
931

Figure 4 FIR filter stages for the VBB and SP velocity channels (upper diagram) and for the VBB position and scientific temperature (SCIT) channels (lower diagram)

932

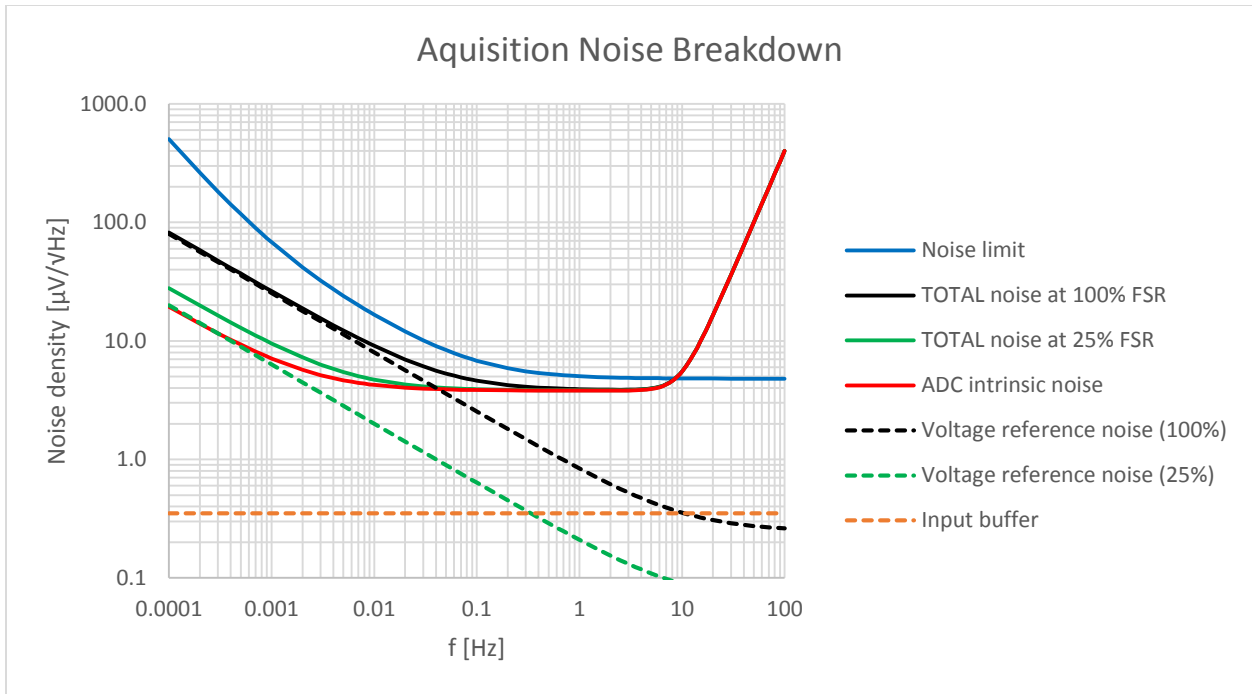

933

934

Figure 5 Acquisition Noise Breakdown of VBB velocity channel. (P. Lognonné, 2019)

935

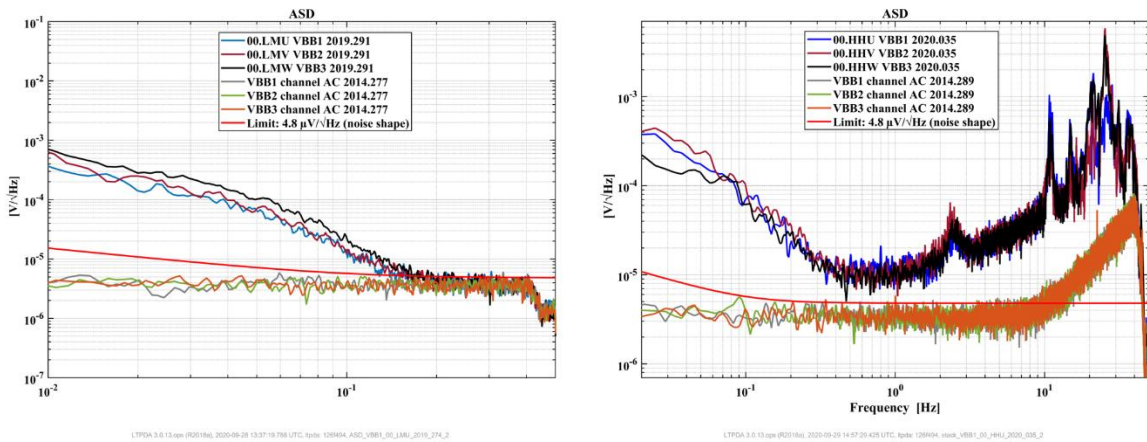

936

937

938

939

940

941

Figure 6 Noise Performance of VBB channels, compared to the acquisition system noise. VBB position channels (left chart) at a sample rate of 1 Hz; recordings from 2019-10-18 at 20:00 for 59 min on Mars and recordings obtained at board level test on 2014-10-04 for 59 min. VBB velocity channels (right chart) at a sample rate of 100 Hz; recordings from 2020-02-04 at 17:52 for 15 min on Mars (event and recordings obtained at board level test on 2014-10-16 for 15 min

942

943

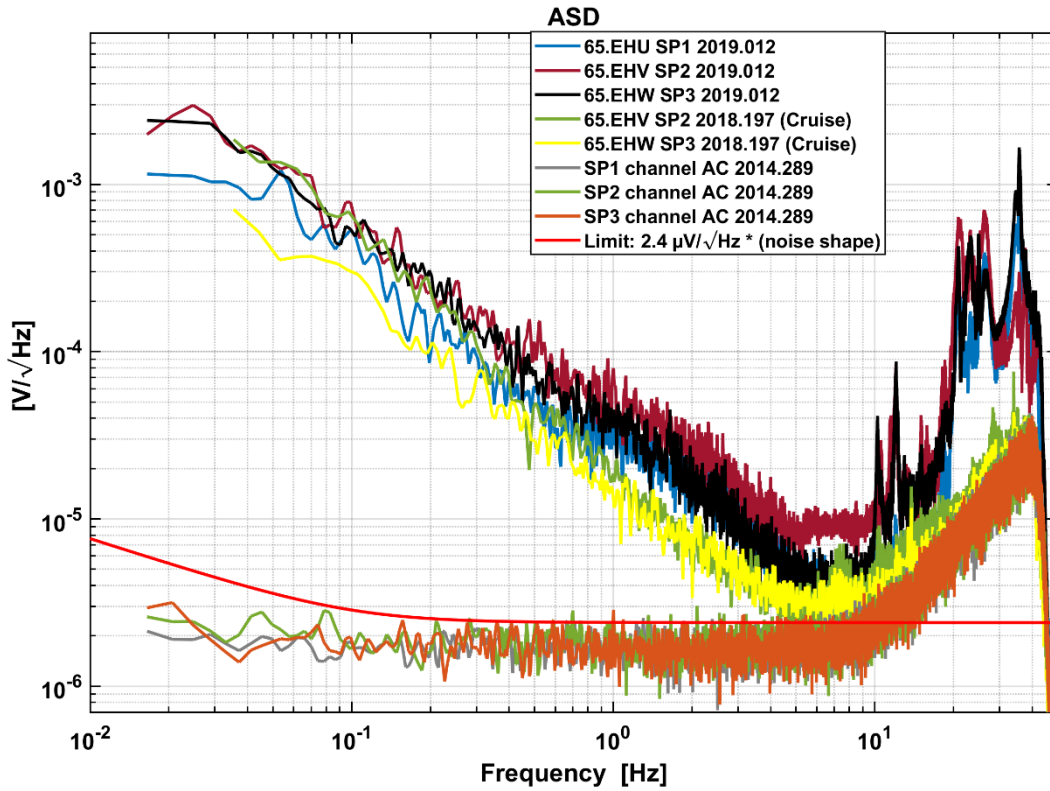

LTPDA 3.0.13.ops (R2018a), 2020-09-27 11:11:43.892 UTC, ltpda: 126f494, stack_SP1_65_EHU_2019_012_1

944

945 Figure 7 Noise Performance of SP velocity channels during cruise and on Mars, compared to the
 946 acquisition system noise; sample rate = 100 Hz; recordings from 2019-01-12 at 05:10 for 15 min on Mars,
 947 from 2018-07-16 at 15:48 for 7 min during cruise, and recordings obtained at board level test on 2014-10-
 948 16 for 15 min

949

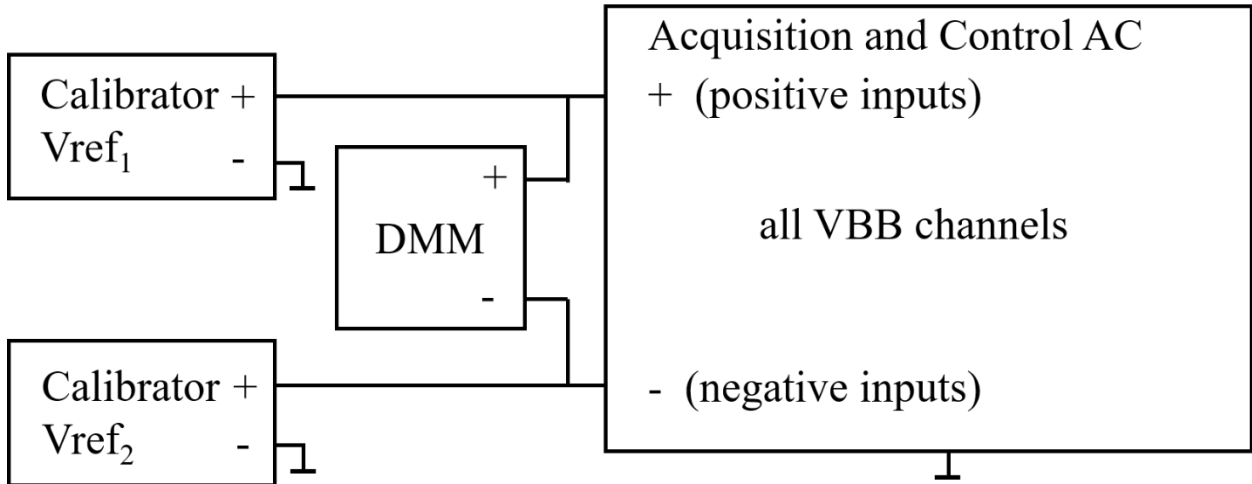

950

951

Figure 8 Linearity Measurement: Principal configuration (block diagram) and measurement results

952

953

954

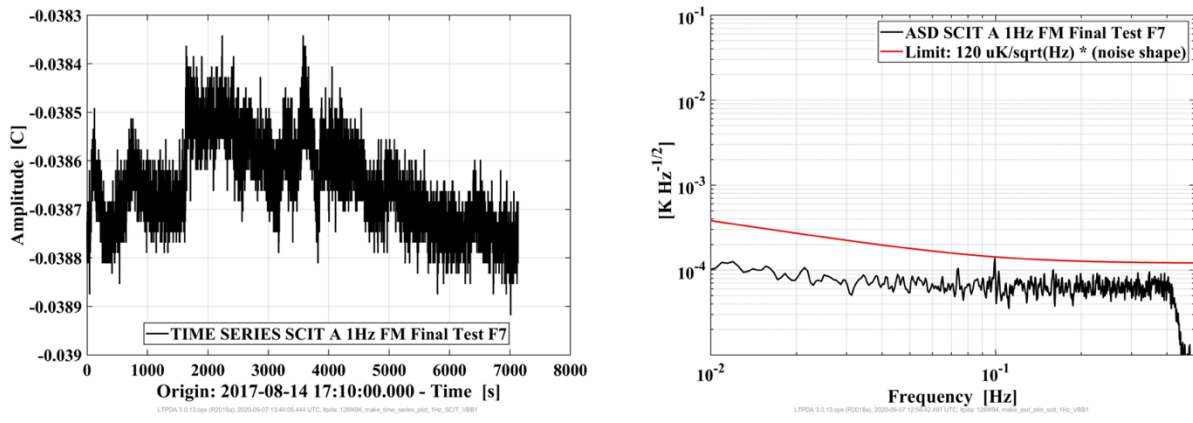

955

956

957

958

Figure 9 Scientific Temperature (SCIT A) time-series and ASD, measured on a fixed resistor instead of a thermistor. Sampling rate = 1 Hz; 2 h time-series; this measurement has been performed in the final test campaign of E-Box FM before delivery to CNES for SEIS integration.

959

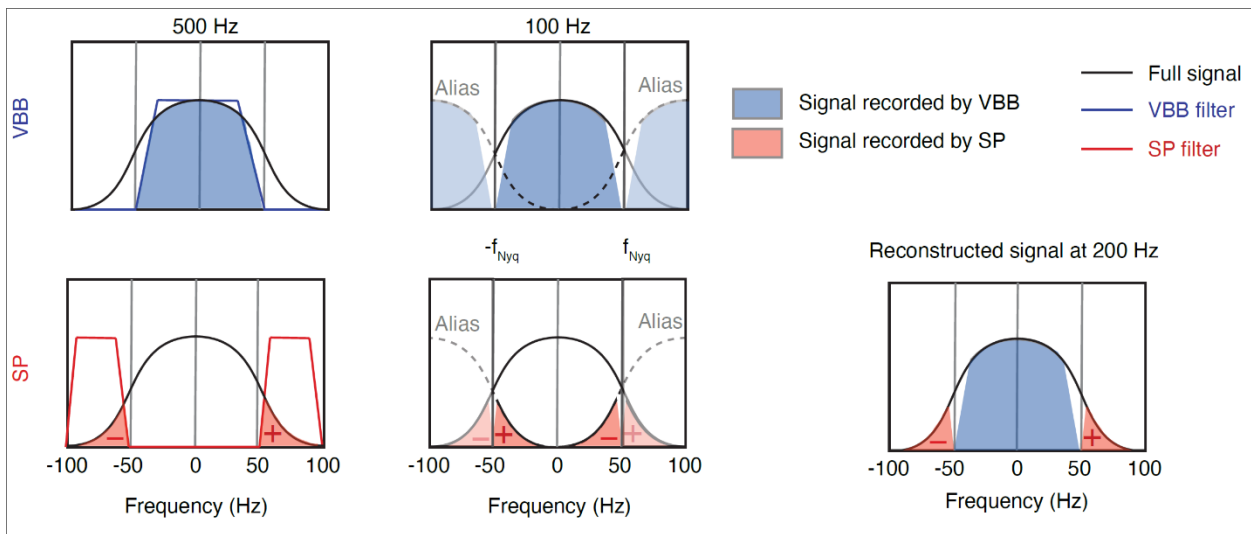

960

961

962

963

964

965

966

967

968

969

970

Figure 10 Sampling strategy to record signals with frequencies up to 100 Hz (simulating a sampling rate of 200 Hz from two separate 100 Hz recordings). (Upper row) The VBB data will be acquired with the standard anti-alias filter (0–50 Hz low-pass filter) when down-sampling the signals digitized at 500 Hz to 100 Hz. (Lower row) The SP data will be filtered with a 50–100 Hz band pass filter, which results in the SP data being folded one time. For the reconstruction of the 0–100 Hz bandwidth (corresponding to 200 Hz sampling; see rightmost sketch), the aliased SP data are folded back before adding the VBB and SP data together. Due to the periodicity of the Fourier transform, down-sampling to 100 Hz will cause the signal to be periodically repeated along the frequency axis at a spacing of 100 Hz (so-called aliases). The different filters used for the SP and VBB channels ensure that the aliases do not overlap, so that they can be individually isolated and used for the reconstruction.

971

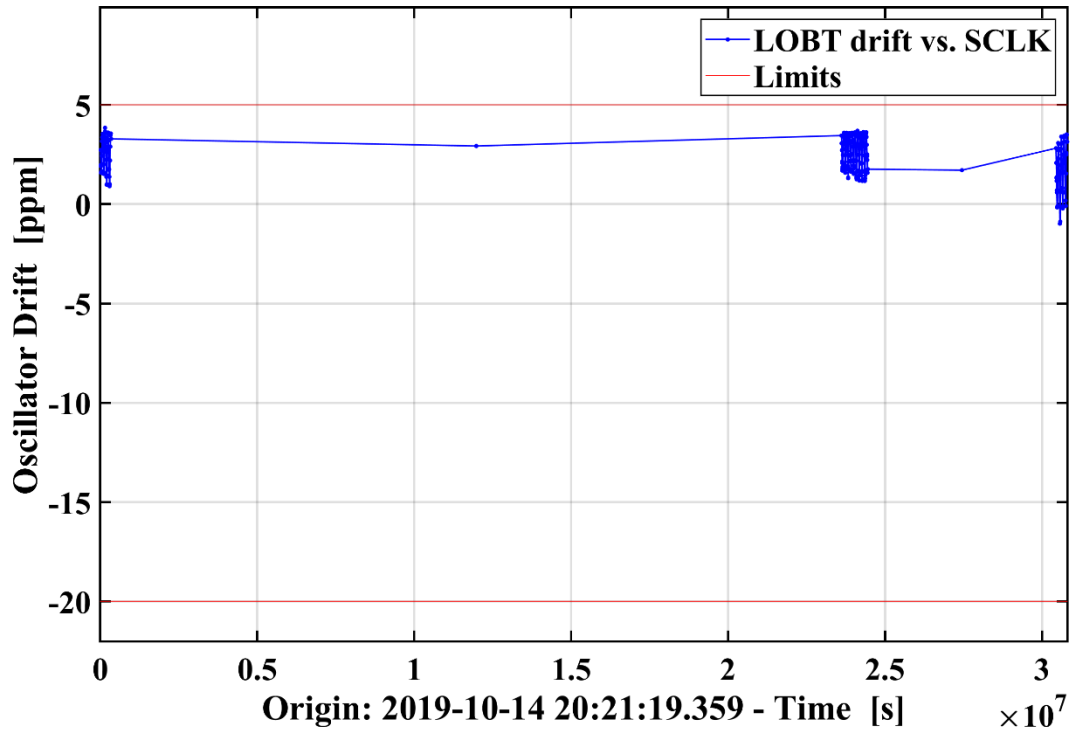

972

973
974

Figure 11 The drift of the LOBT versus the SCLK in the second reporting period from 2019-10-14 to 2020-10-05

975

976

977

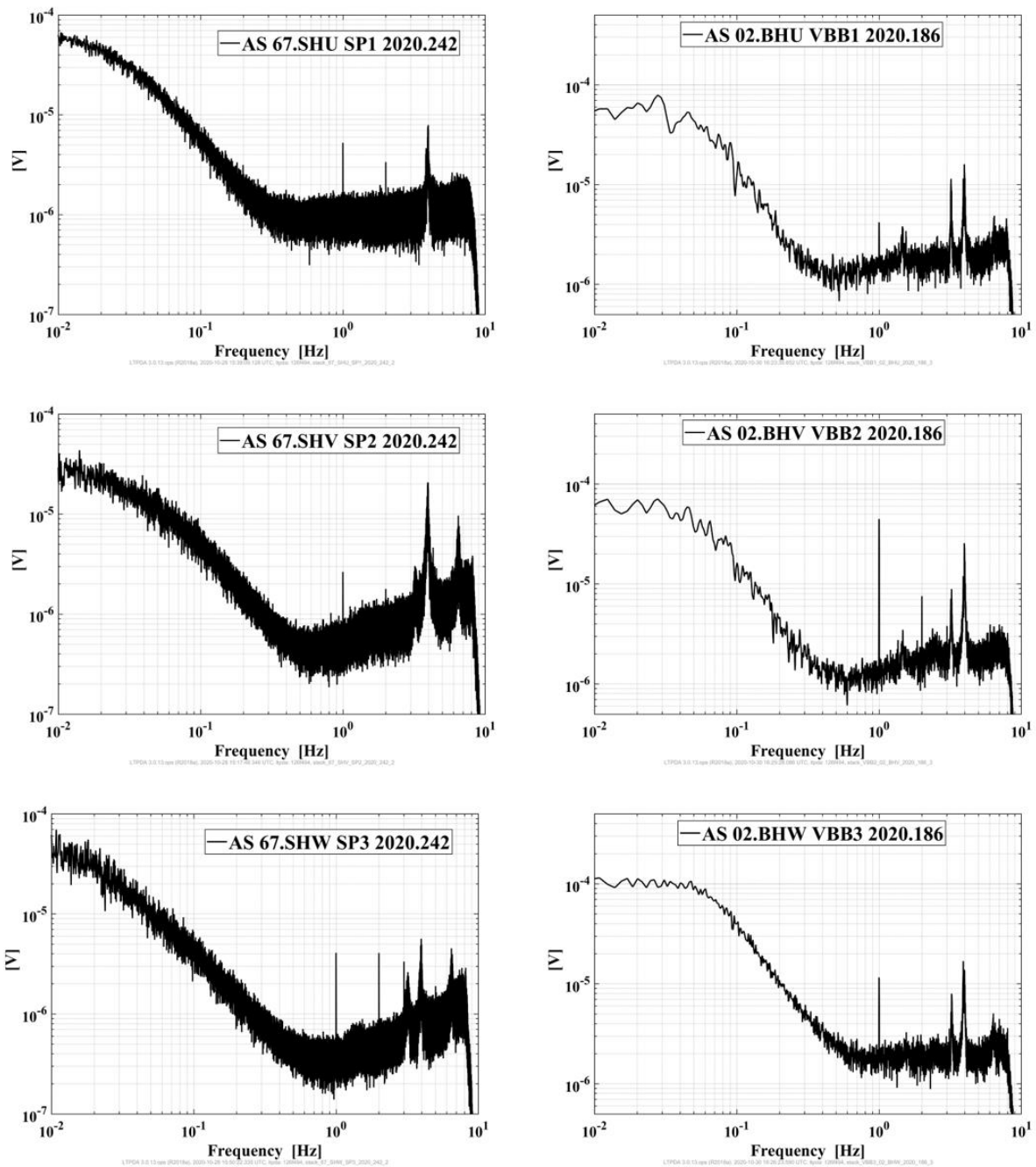

978

979 Figure 12 Left side: Amplitude spectra of SP1, SP2 and SP3 channels at high gain and 20 Hz sampling rate;
 980 24 h time-series; start time 2020-08-29 00:00:00 UTC; tick-noise amplitudes calculated from the samples
 981 of the stacked signal: SP1= 7.2 μ Vrms, SP2 = 3.9 μ Vrms, SP3 = 7.4 μ Vrms. Right side: Amplitude spectra
 982 of VBB1, VBB2 and VBB3 channels in high gain and 20 Hz data rate; 40 min time-series; start time at
 983 2020-07-04 14:50:00; tick-noise amplitudes calculated from the samples of the stacked signal: VBB1 =
 984 7.5 μ Vrms, VBB2 = 49.2 μ Vrms, VBB3 =14.2 μ Vrms

985

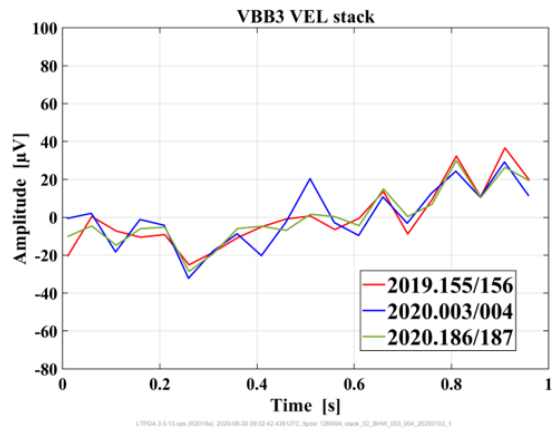
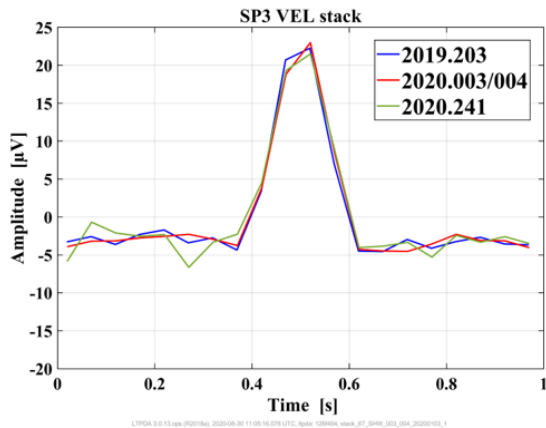
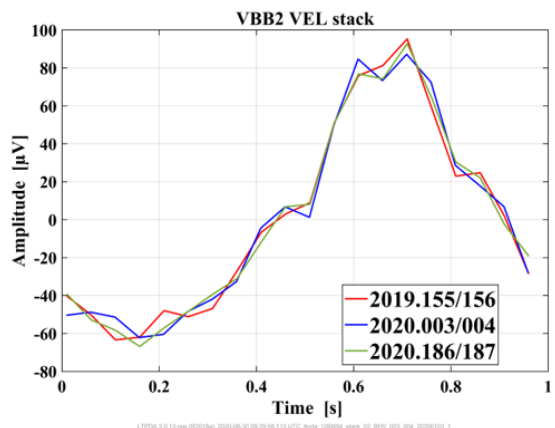
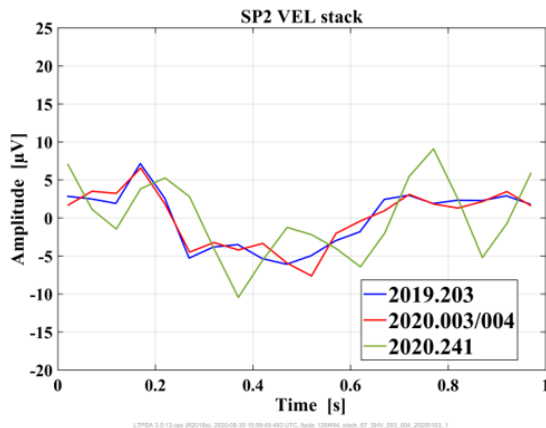
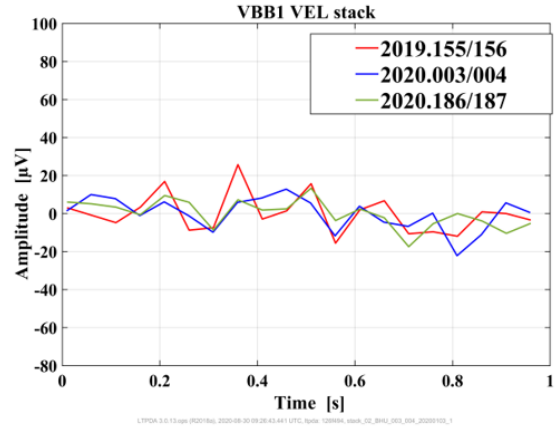
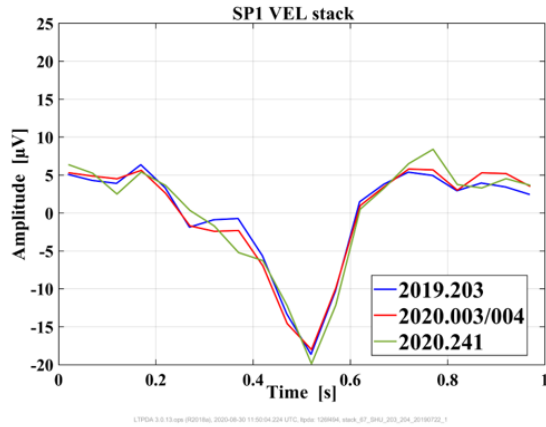

986

987

988

989

990

Figure 13 Left side: Stacked waveforms for SP1, SP2 and SP3 at high gain and 20 Hz sampling rate; recordings from 2019-07-22 (18 hours), from 2020-01-03 (48 hours) and from 2020-08-28 (24 hours). Right side: Stacked waveforms for VBB1, VBB2 and VBB3; recordings from 2019-06-04 (48 hours), 2020-01-03 (48 hours) and 2020-07-04 (48 hours)

991

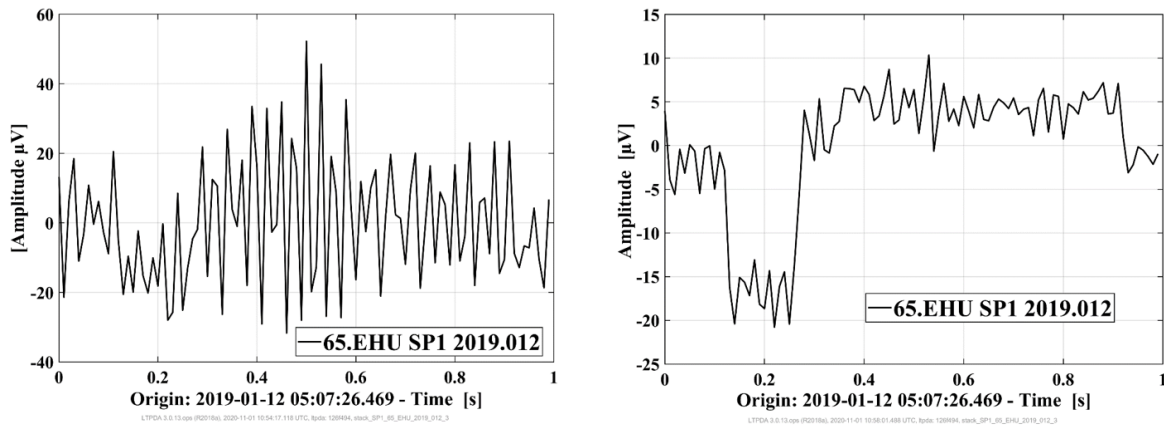

992

993 Figure 14 Comparison of the stacked waveform, SP1, recorded on 2019-01-12 at 05:07:26 for 48 min, with
 994 100 Hz sample rate, high-pass filter with 0.1 Hz corner frequency; left: all available data is stacked, right:
 995 variance level set to 10^4 counts; 328 of 2880 1-second chunks were rejected

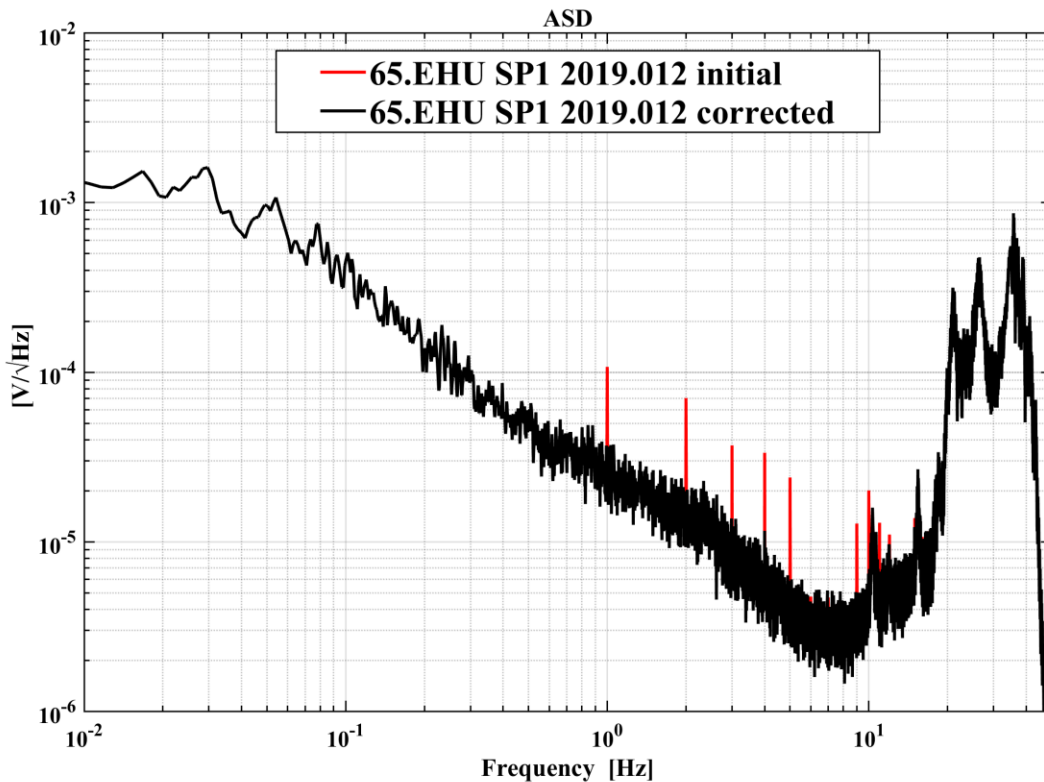

996

997 Figure 15 Corrected SP1 data, high-pass filter with 0.1 Hz corner frequency, accepting waveform chunks
 998 for the stacking process only with a variance below variance level 10^4 counts, as in Figure 14 on the right
 999 side. Data recorded on 2019-01-12 at 05:07:26 for 48 min, with 100 Hz sample rate.

1000

1001 *Appendices (optional)* – equations, figures and tables labeled using “A” (i.e. Table
1002 A1, A2; Figure A1, A2; Eq. A1, A2, etc.)

1003 **Electronic Supplement (optional)** – Authors may submit supplemental digital material
1004 to accompany papers. See [Electronic Supplement Guidelines](#) for further instructions.

1005 If your paper has an electronic supplement, include citations for this material in the
1006 text (i.e. “for a complete list of earthquakes, see Table S4 in the electronic supplement
1007 to this article.”)

1008



Click here to access/download

**Supplemental Material (All Other Files, i.e. Movie, Zip,
tar)**

MATLAB_tickrem_20201221.zip



Click here to access/download

**Supplemental Material (All Other Files, i.e. Movie, Zip,
tar)**

PYTHON_tickrem_20210225.zip