



**HAL**  
open science

## PLANETARY SEISMOLOGY

Philippe Lognonné

► **To cite this version:**

Philippe Lognonné. PLANETARY SEISMOLOGY. Annual Review of Earth and Planetary Sciences, 2005, 33 (1), pp.571-604. 10.1146/annurev.earth.33.092203.122604 . hal-03964106

**HAL Id: hal-03964106**

**<https://u-paris.hal.science/hal-03964106>**

Submitted on 30 Jan 2023

**HAL** is a multi-disciplinary open access archive for the deposit and dissemination of scientific research documents, whether they are published or not. The documents may come from teaching and research institutions in France or abroad, or from public or private research centers.

L'archive ouverte pluridisciplinaire **HAL**, est destinée au dépôt et à la diffusion de documents scientifiques de niveau recherche, publiés ou non, émanant des établissements d'enseignement et de recherche français ou étrangers, des laboratoires publics ou privés.

## Planetary Seismology

Philippe Lognonné

Département de Géophysique Spatiale et Planétaire  
Institut de Physique du Globe de Paris  
4 Avenue de Neptune  
94100 Saint Maur des Fossés, France

also at

Institut Universitaire de France, France

**ABSTRACT :** In contrary to the Earth, the interior of terrestrial planets is poorly known. This is mainly related to the lack of seismic data and of planetary seismic networks on these planets. So far, despite several attempts, only the Apollo seismic network has returned seismic information from the Moon. But even in this case, no seismic signal was recorded after a propagation path through the deep interior and core, due to a hemispheric distribution of the stations on the near side. This review presents the main results achieved by the analysis of the Apollo seismic data and the associated constraints on the internal structure of the Moon. It then presents the seismic apriori for future Martian seismic network missions, as well as a short review on possible seismic missions towards other telluric bodies, such as Venus or the giant planets satellites.

**Key words :** seismology, moon, mars, interior, comparative planetology

### INTRODUCTION

Since the beginning of space exploration, successful missions performing planetary and small bodies seismology have been limited to the Apollo program, with the deployment of a network of 4 seismic stations [Latham *et al.*, 1969, 1970a, 1970b, 1971] in addition to the Apollo 11 seismometer, which stopped operations after one lunation. The eleven other seismometers having left the Earth never recorded any quakes. This includes the two Viking seismometers: operators failed to unlock the first seismometer and the second one provided no convincing event detection after 19 months of nearly continuous operation [Anderson *et al.*, 1977]. The nine other instruments never reached their target, due to the failure of their missions. These were the seismometers onboard the 3 Ranger Lunar probes, in the early 60<sup>th</sup> [Press *et al.*, 1960, Lehner *et al.*, 1962], the two short period seismometers onboard the Phobos landers [Surkov, 1989] and lastly the two Optimism seismometers [Lognonné *et al.*, 1998a] and the two short period seismometers respectively onboard the Small Surface Stations [Linkin *et al.*, 1998] and the penetrators of the Mars 96 mission. For an historical review on planetary seismology, excluding the Mars96 mission

and other later attempts, see *Toksoz* [1975, 1979] and *Lognonné & Mosser* [1993]. The later covered also giant planets seismology, which will not be addressed in this paper.

Despite these un motivating records, international efforts for the deployment of seismometers on the other terrestrial planets continue. The example of Mars shows indeed that most of the recent geochemistry theories in terrestrial planets formations or mineralogical models of Mars are unable to explain the few geophysical data gathered by the recent missions. Martian seismic data, by testing the detailed structure of the Martian mantle, the core size and its seismic activity, will therefore provide key data for assessing the validity of the planetary formation models, for constraining the type of material which have built terrestrial planets and testing theories of planetary evolution.

This review is focusing on the most recent results in planetary seismology of terrestrial planets. With the exception of the Moon, only a few pieces of geophysical information about the inner structure of the planets in the solar system were returned from spacecraft explorations: they are listed in Table 1. The Moon case is therefore the only successful example of planetary seismology. It will be reviewed in details, with a rapid description of the results of the Apollo seismic experiment from the 70<sup>th</sup> and early 80<sup>th</sup> and a detailed review of the works published more recently after different reprocessing of the Apollo seismic data [*Vinnick et al.*, 2001, *Khan et al.*, 2001, *Lognonné et al.*, 2003, *Nakamura*, 2003, 2004, *Gagnepain-Beyneix et al.*, 2004] or re-analysis of the Apollo travel times [*Khan et al.*, 2000, *Khan and Mosegaard*, 2002]. For a more detailed review of the Apollo seismic experiment, see *Toksoz et al.* [1974], *Lammlein et al.* [1974] and *Nakamura* [1983]. We will then draw the present view of the Moon interior obtained from the confrontation of these results with other geophysical and geochemical data. For Mars, we then review the present knowledge of their interior structure and describe the perspective of their future seismic exploration. A priori on the seismic activities, seismic noise and seismic propagation properties of these bodies is first given and the exploration strategy is then precised, including future programmatic issue and instrumentation constraints. The state of the art in the development of space seismometers is briefly presented. We finally present the future challenge in planetary seismology, which will be associated to the seismic exploration the Moon, Mars and of new planets and bodies, especially Venus and the Jovian satellite Europa.

## LUNAR SEISMOLOGY

### The Apollo Seismic Experiment

The first seismometer on a planetary body other than the Earth was installed in July 1969 by the Apollo 11. See instruments details in *Latham et al.* [1969, 1970]. It was a prototype instrument operated by solar panel and stopped after 21 days [*Latham et al.*, 1969, *Latham et al.*, 1970a, 1970b]. Later, with the other Apollo missions, a network of 4 seismometers, continuously powered by RTG, was deployed and turned off after command from the Earth in September 1977. The huge amount of data collected along

the 26.18 active station years is now available in raw format in the IRIS DMC center and also in the IPGP data center in mini-SEED format [Gagnepain-Beyneix *et al.*, 2002]. Recorded seismic events are either impacts (meteorites and artificial impacts) or quakes (deep and shallow also named HFT events). During the 7 years of the Apollo seismic network operation, more than 10000 seismic signals were observed.

Figure 1 show typical example of the deep Moonquakes. Their depth is ranging from 700 km to 1000 km, and they occur repeatedly on a small number of distinct foci with periodicity related to the Moon orbits, especially periods of 27 and 206 days. Latham *et al.* [1971], Lammlein, [1977], Goins *et al.* [1981a] have performed detailed analysis of these events, in term of magnitude, location, stress drop and proposed mechanism. They have shown that their maximum amplitude, typically of only a few digital units on the LP records, and initial polarity appear to be correlated with the tidal cycle [Lammlein, 1977] and that the largest deep Moonquake nest in term of magnitude, the A1 site, releases events with seismic moment of about  $5 \cdot 10^{13}$  N m, characterised by corner frequency of about 1 Hz and a stress drop of 0.1 bar. Further source studies have shown that the radiation patterns of deep moonquakes from a single source region was rotating with changes in tidal stress [Nakamura, 1978]. By using single link cluster analysis, Nakamura [2003] has more recently increased the number of detected deep moonquakes signal to more than 7200. More than 160 moonquakes epicenters have been found, and associated to signals observed at several Apollo stations, and this number might increase with further studies, especially with the search of deep moonquakes originating from the far side of the Moon [Nakamura, 2004, Oberst and Mizutani, 2003]. Stacking methods have been used to generate better seismograms from all events originating from a given source (See Figure 1), not only in the original studies (e.g. Nakamura, 1983), but also in the more recent studies [Lognonné *et al.*, 2003, Nakamura, 2003]. More detailed analysis however shows that the events have slightly different positions for the epicenter, and that stacking methods are less efficient for the short period data [Gagnepain-Beyneix *et al.*, 2004].

Figure 3 shows the compilation of the natural impacts, while an example of artificial impact is shown on Figure 2. Apart informations on the internal structure, these events have been also used for the determination of the orbital characteristics of the meteoroid impacting the Moon [Oberst & Nakamura, 1987, 1991] and the mass of meteorite has been estimated [Oberst & Nakamura, 1991, Lombardi *et al.*, 2002]. The last signals are the HFT moonquakes. They are much stronger [Nakamura, 1977] but only 28 such events were observed in 5 years.

All these seismic data show an intense scattering and reverberation in the crust and subsurface. This is characterizing the records by a linear rise of the seismic energy with time after the beginning of the signal, typically during 10 mn, a stationary maximum and then a slow decreases. An exact description of the scattering process from the elastic wave equation seems to be extremely difficult, and thus only approximations have been used, such as diffusion theory [Dainty *et al.*, 1974, Nakamura, 1976, 1977a]. Both experiments [Dainty *et al.*, 1974] and observations [Toksoz *et al.*, 1974] show that the scattering zone, probably related to the fracturation of the

crust, must be located within a near surface zone between 1 and 20 km thick, and that below 20 km the scattering is much weaker. *Nakamura* [1977a] has however shown that the size distribution of scatters is very close to those of craters on the Moon, and that cratering is probably one of the principal causes of scattering, by creating irregularities of the surface and associated subsurface fracturations. Only a few attempt in the waveform modeling of these waves have been done, mainly due to the lack of available models but normal modes technics, even up to frequencies of 0.3Hz, can provide rough estimate of the mean amplitudes of the P and S pulse which are typically found within 20-30% of those of the data [*Lombardi et al.*, 2002].

The lack of broadband performances of the Apollo seismometers, the low amplitudes of the quakes and the intense diffraction have severely limited the analysis of the seismograms. Practically, with the exception of crustal phases, tentatively identified on single records by *Toksöz et al.* [1972a,1972b] and *Goins et al.* [1981a] and of more recent receiver function analysis based on the P to S conversion at the crust [*Vinnick et al.*, 2001], only direct P and S arrival times have been used for the determination of seismic models. 81 sources were compiled and used at the end of the experiment for global seismic velocities inversion by *Nakamura* [1983] with 18 meteorites impacts, 8 artificial impacts, 14 shallow events and 41 deep Moonquakes but without a systematic record for all the arrival times. These 81 sources provided 203 P and 243 S leaving 162 degree of freedom available for the internal structure, apart the time and locations of the sources, unknown for all but the artificial impacts. Due to the probable presence of a few bad pics in this data set [*Khan and Mosegaard*, 2002, *Nakamura*, 2003] and of data with large errors (some times more than a few 10s of second between different authors reading), *Lognonné et al.* [2003] and *Gagnepain-Beyneix et al* [2004] did a new arrival time picking and selected 59 events with the smallest errors (19 natural impacts, 8 artificials, 24 deep Moonquakes and 8 shallow quakes, with a mean error of about 2 sec), leading to 183 P and 136 S arrival times, with 17% less (134) degrees of freedom for the internal structure despite 27% less quakes used. Other studies were done with the same data set as *Nakamura* [*Khan et al.*, 2000, *Khan and Mosegaard*, 2002] or with less events, as for *Goins et al.* [1981b] who have used 40 events (8 natural impacts, 8 shallow quakes and 24 deep Moonquakes) or for *Koyama and Nakamura* [1979] who used 25 events. The low number of degree of freedom for internal structure (134-162) and the low quality of the data is the main limitation in the proposed models of the Moon interior. It leads to a large trade-off between depth resolution and a posteriori uncertainties, as we will see below.

### **Subsurface And Crustal Thickness Determination**

Very low seismic velocities are observed in the regolith subsurface (see *Cooper et al.* [1974] for a review). They produce an amplification of short period seismic waves by reverberations and a lost of the seismic pulse coherency. The subsurface structure has been studied with active seismic experiments, on the 14, 16 and 17 sites [*Cooper et al.*, 1974], with the passive seismometers and signal of the lunar module lift-off at the 11, 12,

14, 15 [Nakamura *et al.*, 1975], by frequency analysis of the horizontal-to-vertical amplitude ratio of natural events at 12, 14, 15 and 16 [Horwath *et al.*, 1980] and lastly by the receiver function method at the 12 landing site [Vinnick *et al.*, 2001].

The first 10 to 20 meters have shear velocities below 100 m/s while S velocities higher than 300 m/s are found deeper than 100-200 m. Such structures are producing resonances at frequencies higher than 1-2 Hz, making the analysis of arrival time difficult. Below these layers and up to 1-1.5 km a layer with  $V_p$  from 1000 m/s to 2000 m/s was generally found, interpreted as a fractured and broken zone extending to the lower crust discontinuity, where  $V_p$  rises respectively up to 4.7-4.9 km/s [Cooper *et al.*, 1974; Nakamura, 1983]. The Apollo 12 landing site has the smallest thickness of regolith [Horwath *et al.*, 1980, Mark and Sutton, 1975] and is of particular interest for the future Lunar-A mission, which will deploy one of the two penetrators in its vicinity. Vinnick *et al.* [2001] suggested that the high-velocity basement (i.e. shear velocities higher than 1000 m/s) at station 12 should be about 150 m deep, a depth twice smaller than the one proposed by Mark and Sutton [1975]. A correlation between the horizontal components of motion at station 12 was also found, with a stable polarisation of the waves with a  $-60^\circ$  North azimuth, pointing out toward the 100km near Lansberg impact crater (42 km in diameter) [Vinnick *et al.*, 2001, Chenet, 2003] which might be explained by reverberations between the impact generated fractures.

The volume of the lunar crust is directly related to the depth of the post-accretional magma ocean and of the efficiency of the primary crust differentiation. Moreover, due to the concentration of radiogenic elements in the crust, its thickness is constraining strongly the bulk inventory of U and Th of the planet [e.g. Taylor, 1984]. Its determination is therefore a key objective of seismology. A thickness of 65 km was proposed after the pioneer work of Toksöz *et al.* [1972a, 1972b] developed later by Toksöz *et al.* [1974]. But such estimation has been questioned recently with the works of Khan *et al.* [2000], Khan and Mosegaard [2002] and Chenet *et al.* [2000], Chenet [2003], Lognonné *et al.* [2003], who have independently proposed a much thinner thickness. Using the same data than Nakamura [1983], Khan and Mosegaard [2002] performed indeed a Monte-Carlo inversion. They got a rapid increase between the surface and 20 kilometers and then a slower increase down to a 40 kilometers discontinuity [Figure 4a]. After an earlier estimate of  $45 \pm 5$  km [Khan *et al.*, 2000], they consider a shallower crust-mantle boundary, around  $38 \pm 3$  km deep, to be 4 times more likely than a discontinuity between 50km and 70km deep. Lognonné *et al.* [2003] and Gagnepain-Beyneix *et al.* [2004] have found a velocity increase at a depth of about 30 km and even with a joint inversion travel times and of S to P converted phase, obtained from a receiver function analysis [Vinnick *et al.*, 2001], found no major discontinuity at 45 or 58 km compatible with both the travel times and the amplitude of the SP converted phase [Figure 4b]. By taking into account the crustal lateral variations Chenet [2003] and Chenet *et al.* [2004] obtained a mean crustal thickness on the near side, in PKT terranes of  $34 \pm 5$  km, a value close from the transition observed by Khan *et al.* [2002], who took some of the lateral variations into account by inverting also a delay time at all Apollo stations.

All these recent estimates are therefore significantly smaller than the original 65 km, a value also challenged by *Koyama & Nakamura* [1979] with a 45 km crustal thickness from a global inversion of travel times, explained mainly by smaller velocities in the lower upper mantle ( $V_p=7.85 \pm 0.04$  km/s,  $V_s=4.31 \pm 0.03$  km/s) as compared to previous results ( $V_p=8.10$  km/s,  $V_s=4.70$  km/s). Let us go back to the *Toksöz* [1972a] paper with its 60 km value estimation. The main argument used was the amplitude amplification at an epicentral distance of about 170 km. *Toksöz et al.* [1974a,1974b] explain this amplification by a ray focusing at this distance. This was however strongly dependant on the velocity value used below the boundary and values as high as  $8.9 \text{ km}\cdot\text{s}^{-1}$  were necessary. But as noted by *Toksöz et al.* [1972a] in a “Note added in proof”: “*The first detectable motion at the Apollo 15 seismometer indicates an average velocity of at least 8 km/s near a depth of 130km. Whether the high velocity (9km/s) zone in the uppermost portion of the mantle (reported above) is a universal feature or not cannot be determined from the new data*”. None of the further studies have found such high values and only velocities in the range  $7.6\text{-}7.9 \text{ km}\cdot\text{s}^{-1}$  where reported [*Goins et al.*, 1981, *Nakamura*, 1983; *Lognonné et al.*, 2003, *Gagnepain-Beyneix et al.*, 2004].

The comparison of  $V_p$  of the different seismic models with those extrapolated from the lunar samples, as shown on Figure 4b is also supporting models with smaller velocities in the crust. The *Toksöz* values and even the *Khan* values appears to be high with respect to the experimental ones, in opposition of *Lognonné et al* [2003] and *Gagnepain-Beyneix et al.* [2004] values, more in the range of the crustal velocities. In conclusion and from the most recent studies, a depth ranging from 30 to 40 km in the PKT terranes seems likely from the more recent reprocessing or inversion of the Apollo seismic data. Such range is also supported by other seismic arguments, such as the mantle temperature, as constrained by the upper mantle seismic data [*Gagnepain-Beyneix et al.*, 2004]

### **The Moon Mantle : A Pyroxenite Upper Mantle With A Primordial Lower Mantle ?**

Figure 5 shows the different seismic models of the mantle, found by various studies with values summarized in Table 1. Two approaches were chosen. The first is an inversion of a models with only a few layers and generally for both  $V_p$  and  $V_s$  [*Goins et al.*, 1981, *Nakamura*, 1983, *Lognonné et al.*, 2003, and *Gagnepain-Beyneix et al.*, 2004]. Typically, 3-4 layers have been inverted in the mantle and 4-6 layers in the crust, leading to about 20 parameters in the inversion, as compared to 130-160 degree of freedom of the data set. Such approach takes into account the low sensitivity of travel times to gradient and allows the determination of the mean velocity in each layer while reducing the a posteriori error by about  $\sqrt{(6-8)}$  compared to the a priori errors associated to the travel times readings and mislocation of the events. It moreover allows a systematic exploration in the model space, as performed by *Lognonné et al.* [2003] and *Gagnepain-Beyneix et al.* [2004]. *Khan et al.* [2000], *Khan and Mosegaard* [2002] in contrary used much more layers (56 with the two  $V_p$  and  $V_s$  parameters) and a Markov Chain Monte Carlo technique for the inversion. Larger errors in the a posteriori

velocities are found, leading to weaker constraints in term of mineralogy [Figure 5]. Moreover, as noted by *Kuskov et al* [2002], the velocities with the highest marginal probabilities are not within the range of seismic velocities obtained by mineralogical considerations. We will therefore mainly discuss the seismic values of the *Goins et al.* [1981], *Nakamura et al* [1983] and *Gagnepain-Beyneix et al* [2004] models and will use the results of *Khan and Mosegaard* [2002] for the relative velocities variations with depth.

These models agree fairly well in the upper mantle (i.e. the first 300 km deep), with a mean value of 4.47 km/s and 7.70 km/s between the three models and maximum differences of 0.05 km/s and 0.10 km/s, comparable to the proposed errors. Deeper, *Nakamura's* model shows a strong decrease of both  $V_p$  and  $V_s$  velocities, with a low velocity zone between depth of 270 km and 500 km. Such feature is not observed with the models of *Goins et al* [1981] and *Gagnepain-Beyneix et al.* [2004]. No decrease is also observed by *Khan and Mosegaard* [2002] in the upper mantle with quite constant velocities in the mantle, up to a depth of 500 km.

Deeper, an increase of the seismic velocities is found by *Nakamura et al.* [1981] at a depth of 500 km and at a depth of 738 km for *Gagnepain-Beyneix et al.* [2004]. *Khan and Mosegaard* [2002] found also an increase of velocities in the lower mantle but no stable velocities are found for P up to 800 km deep. Stable velocities for S are however found at depth of 550 km. This increase in the seismic velocities is probably the signature of a transition between the upper's Moon mantle and the lower ones. But more data will be necessary for precising its depth (in the case of a rapid discontinuity) or the depth and extension of the gradient zone (for a more gradual discontinuity) as pointed out by *Hood* [1986]. Indeed, *Lognonné et al.* [2003] have shown that the inverted values at this depth depend mainly on a few rays. Models closer from *Nakamura's* one are found when the five deepest rays are excluded from the data set. Such poor resolution of the structure between 400 km and 800km deep is probably explaining the absence of clear maximum in the marginal probabilities of P velocities found by *Khan and Mosegaard* [2002].

These models have led to several interpretation in term of mantle mineralogy. If *Buck and Toksoz* [1980] discussed earlier results, *Hood and Jones* [1987], *Mueller et al.* [1981], *Kuskov et al* [1994,1995, 1997, 1998] discussed mainly *Nakamura* [1983] model. *Hood and Zuber* [2000] and *Kuskov et al* [2002] interpreted both the models of *Nakamura* [1983] and of *Khan et al.* [2000]. *Lognonné et al.* [2003] and *Gagnepain-Beyneix et al.* [2004] provided a mineralogical interpretation of their models based on *Kuskov's* papers. In the upper mantle, as noted by *Kuskov et al.* [1995], *Lognonné et al.* [2003] and *Gagnepain-Beyneix et al.* [2004], these velocities are compatible with pyroxenite compositions. Two possible compositions, with rather different FeO compositions (13.8% and 17.6%) and Mg# number of 75 and 72 respectively fit fairly well the seismic velocities. The first was proposed by *Ringwood and Essene* [1970] as a possible source of mare basalt originating from depth of 200-500 km. The second was proposed by *Kuskov et al.* [1995] in order to explain the lower bound of the *Nakamura* model. If both fit the seismic velocities, the density of the second is too high to fit the density constraints of the upper mantle



given by the inertia factor and mean density. Both the geochemical [Taylor, 1987] and the geophysical arguments in contrary support the first composition (i.e. FeO around 13% and Mg# of 75).

The increase of velocity, found by Nakamura *et al* [1983], Beyneix *et al.* [2004] and Khan and Mosegaard [2002] deeper has been interpreted as the signature of a discontinuity in the composition of the Moon mantle, separating an upper differentiated mantle from a lower primordial mantle. Nakamura [1983] propose a depth of 500 km and Khan and Mosegaard [2002] 550 ± 20 km. For Gagnepain-Beyneix *et al.* [2004] the data are too sparse for resolving a gradual increase of the velocity between 400 and 750 km from a discontinuity. Hood and Jones [1987] and Mueller *et al* [1981] proposed an increase in the Mg# in this transition zone relative to the upper mantle, related to the primordial magma ocean of the Moon. Kuskov and Fabrichanskaia [1994], Kuskov [1995] and Kuskov *et al* [2002] confirmed that no mineralogical transformation can produce such increase in the seismic velocities. Note that the same argument is however true for the decrease in seismic velocities proposed by Nakamura [1983] at the top of their low velocity zone (at a depth of 300km). These mineralogical interpretation of the seismic profiles are however not well adapted to the low quality velocity models: future steps are necessary with direct inversions of the seismic travel times and other geophysical data in term of mineralogy [e.g. Verhoeven *et al.*, 2004].

### The Seismically Unknown Lower Mantle And Core

All Apollo seismic stations were located on the near side of the Moon and no seismic signal associated to ray propagating through the core were detected [Figure 6] with the exception of a few meteorite impacts [Nakamura, 1974]. No events on the far side of the Moon have been identified so far despite recent search for the identification of such quakes [Nakamura, 2003, 2004]. Both studies suggest therefore that the very deep Moon mantle below the deep moonquakes sources (1000km) strongly attenuates or deflect seismic waves. But its seismic velocities remain unconstrained.

Many studies are however supporting a small core (see Hood and Zuber [2000] for a review). Some arguments are from geochemical analysis and mare basalt samples show indeed a depletion of highly siderophile elements [e.g. Righer *et al.*, 2000] but could be attributed to the formation of the proto-Moon core. Most geophysical arguments are stronger. Hood and Jones [1987], Bills and Rubincam [1995] showed that a priori mantle density profiles cannot explain alone the mean density and inertia factor. A small core is mandatory for these data, as well for explaining the induced magnetic dipole moment produced by the interaction of the Moon with the Earth's geomagnetic tail, which need a 340±90 km conductive core [Hood, 1999]. Finally, Williams *et al.* [2001] have shown that the rotation of the Moon was influenced by a dissipation source, which can be interpreted as the signature of a liquid core.

Due to the sensitivity of the low angular order normal modes to the core structure, the search for free oscillations in the Apollo data has been performed by a few authors. After a first unsuccessful attempt of Loudin

and Alexander [1978], Khan and Mosegard [2001] claimed recently a successful detection of free oscillations from large band Apollo signals generated by meteorites impacts. The seismograms used by Khan and Mosegard [2001] are the strongest natural impacts of the profile shown in Figure 3. The seismic signals are still weak and these impacts can be compared in magnitude to the impacts of the Saturn IVB (Figure 2). The mass and velocity give an impulse of  $3.82 \cdot 10^7$  Ns and an impulse 25 times larger (i.e.  $10^9$  Ns) will generate seismic waves saturating all Apollo seismometers in the .3-1Hz frequency range (only 512 DU of dynamic were available on the Apollo seismometers). This upper estimate of the impacts used by Khan and Mosegaard [2001] can be used to model the amplitude of seismograms, for a spherical Moon model and with normal modes seismograms [Lognonné and Clévéde, 2002]. Figure 7a shows clearly that even in this upper case, the spectral amplitude of the signals are two orders of magnitude smaller than the instrument noise, greater than  $10^{-9} \text{ ms}^{-2}/\text{Hz}^{1/2}$  at frequencies smaller than 10 mHz. If we furthermore consider that the 3D structure and the scattering of the crust and upper mantle are reducing these amplitudes and that a more precise analysis of these large events gives an upper limit of about  $3 \times 10^8$  Ns [Lombardi et al., 2001], the signal to noise ratio achieved in the normal mode bandwidth [1-10 mHz] is by 2 to 3 orders of magnitudes smaller than 1 for these Apollo data.

The other candidates for such normal mode excitation are the HFT events with seismic moments up to  $1.6 \cdot 10^{15}$  Nm [Oberst, 1987]. A scaling of the amplitude of Figure 7b, computed for a shallow quake with moment of  $10^{18}$  Nm shows amplitudes in the range of  $10^{-10}$ – $5 \times 10^{-10} \text{ ms}^{-2}/\text{Hz}^{1/2}$  in the normal mode bandwidth. If such amplitudes are still too small for the Apollo seismometer noise, they could be detected with modern VBB seismometers or superconducting gravimeters, if continuous operation during 5-10 years is possible [Gudkova and Zharkov, 2002].

In the absence of Normal modes and of core phases, the density, moment of inertia, Love number  $k_2$  and magnetic properties of the core are the only parameters able to constrain the core but can be jointly inverted with the seismic constraints on the mantle and crust. Such joint analysis was done first by Bills and Ferrari [1977] with the density, moment of inertia and a preliminary seismic model. More recent are from Kuskov and Kronrod [1998], Kuskov et al. [2002] with the Nakamura [1983] seismic models and with the improved density and inertia factors. Either a pure  $\gamma$ -Fe core with density of  $8100 \text{ kg/m}^3$  and a radius of 350 km, or a core with smaller densities and larger radius, including the largest troilite FeS core with a radius of 530 km and a density of  $4700 \text{ kg/m}^3$  were proposed. With the same inertia factor and mean density, but with their seismic model, Lognonné et al. [2003] have found for a 350 km core, densities in the range of  $7000 \text{ kg/m}^3$  to  $8000 \text{ kg/m}^3$ , depending on the thickness of a  $2910 \text{ kg/m}^3$  dense crust. These results can be compared to the latest results performed without seismic a priori and based on a 5 shells model of Khan et al. [2004], for which a core with a radius of about 350 km and a density of  $7200 \text{ kg/m}^3$  is found.

## MARS SEISMOLOGY

The last 15<sup>th</sup> years have been rather disappointing for Mars seismology. The early 1990 indeed started with great prospects for the seismic exploration of Mars, with the ambitious soviet Mars94 mission, the latter with a very large orbiter, two small autonomous stations equipped with the short period Optimism seismometers [Lognonné *et al.*, 1998] and 2 penetrators. At the same time started the assessment phase of the joint NASA-ESA Mesur-Marsnet [Solomon *et al.*, 1991, Chicarro *et al.*, 1991, 1993] with a goal of up to 16-20 seismic and meteorological stations, including the 4 ESA's Marsnet ones. However, budgetary and programmatic problems in 1993 lead to the postponement of the Mars94 mission to 1996 and the lost of the Mars Observer mission forced NASA to cancell Mesur. In 1996, hope was back with the last preparation for Mars96 launch and with a new ESA-NASA InterMarsnet phase A, that time with a more reasonable network of 4 stations [Banerdt *et al.*, 1996]. But again, InterMarsnet did not went thru the ESA's selection processes and a few months later, Mars 96, after a successful launch, failed its insertion into a trans-Mars trajectory and fell down in the Pacific.

But the strikingly consistent "Phoenix" character of Network mission was ready for a new re-birth in 1997 with the NetLander mission [see Sotin *et al.*, 2000 for a special PSS issue]. Despite two attends for an ESA launch (on the MarsExpress mission or the possible F2/F3 MASTER mission), the European and US Netlander team had to rely on the major collaboration between NASA and CNES for reaching Mars as a piggyback passenger of a Mars Sample Return orbiter. But again, programmatic and budgetary problems lead the project to collapse in 2003, during the phase B of the mission [Butler, 2003], two years after the cancellation of the sample return efforts.

### Interior Structure Of Mars

Mars interior remains therefore largely unconstrained and only the 4 geophysical numbers (mean density, inertia factor, real and imaginary  $k_2$  value) are available in addition to the constraints put by SNC meteorites and by mineralogical or cosmochemical models. See Spohn *et al.* [1998] for a review on the Mars interior and the use of these constraints.

Seismic models of Mars were however proposed by several authors since the Viking mission. Okal & Anderson [1978] based their model on the future PREM [Dziewonski and Anderson, 1981] and with a core size adjusted to the sole mean density. Sohl and Spohn [1997] and Zharkov and Gudkova [2000] used an estimated value of the inertia factor ( $C=0.365$  Ma<sup>2</sup> instead of the observed  $C=0.366\pm 0.0018$ ) corrected from the non-hydrostatic contribution of the Tharsis buldge as well as geochemical constraints (Figure 8). The later were based on the Dreibus and Wänke [1989] mixture models which Mars is a mixture of 40% volatils rich and 60% volatile depleted C1 material constrained by the composition of the SNC meteorites. But other mixtures models have been proposed in order to match the  $\delta^{17}\text{O}/\text{d}18\text{O}$  between ordinary chondrite H, enstatite chondrite EH and H chondrite, [Sanloup *et al.*, 1999, Lodders and Fegley, 1997]

However, these geochemical models generally do not agree with geophysical data, even for both the mean density and inertia factors. *Sanloup et al* [1999] model for example provides an inertia factor of  $C=0.365 \text{ Ma}^2$ , while *Dreibus and Wänke* [1989] model gives  $C=0.357 \text{ Ma}^2$  [*Sohl and Spohn*, 1997]. While this discrepancy might be related to inadequations of the geochemical models, *Gudkova and Zharkov* [2004] proposed to further consider light elements in the core, especially Hydrogen, in order to decrease the density of the core and therefore to increase the inertia factor (i.e. by reducing the density contrast between mantle and core) while keeping the mass of the planet constant (i.e. by increasing the core size). If the chalcophile depletion of SNC indicates probably a sulfur rich core, very little constraints on the amount of hydrogen are indeed available, as well as for other light elements. Hydrogen was however available in great amount during the formation of the planet in enough quantities to built a pure FeH core. Other arguments are supporting a large core with light elements. The first one is the newly determined value of tidal  $k_2$  Love number of Mars ( $0.153 \pm 0.017$ , [*Yoder et al.*, 2003]). Such high value needs models with large core radius as shown also by *van Hoolts et al.* [2003] and Figure 9 shows that that the best fit is achieved with those models with hydrogen, while the other without hydrogen (Model M8 of *Gudkova and Zharkov* [2004] or model A of *Sohl and Spohn* [1997]) do not explain  $k_2$ . While the core radius is 1468 km for model A, it is 200-300 km larger for the preferred models M6 and M7 (1662 km and 1753 km respectively). Corresponding density at the CMB are  $6936 \text{ kg m}^{-3}$ ,  $6279 \text{ kg m}^{-3}$ ,  $5901 \text{ kg m}^{-3}$ . The second is related to the apriori liquid state of the core. A liquid core is indeed supported by both the Phobos tidal acceleration value and of the large  $k_2$  value. As noted by *Lognonné & Mosser* [1993] and *Zharkov and Gudkova* [1997], a low Martian Q at the Phobos tidal period will imply unrealistically low intrinsic Q of the planet if the core is solid and tidal stresses are distributed along the full solid planet. In contrary, Q corresponding to silicate material slightly colder than the Earth mantle are found for a liquid core [*Lognonné & Mosser*, 1993]. But as for the Earth [*Hillgren et al.*, 2000], Hydrogen and Sulfur are however not the only candidate and other elements could be advocated for a lighter density of a liquid core, especially Si [*Stevenson*, 2001, *Sanloup et al.*, 2002], O or C.

From a geochemical point of view, a large core increases the Fe/Si ratio to values closer from the 1.71 of SNC's. Indeed, Fe/Si ratio for two best models M6 and M7 are 1.55 and 1.68, much larger than the 1.35 of model A from *Sohl and Spohn* [1997]. But a larger core has also major consequences on the internal structure and planetary evolution. The first one is to make a perovskite-bearing lower mantle impossible, due to insufficient pressures in the present mantle. An endothermic phase transition from spinel to perovskite has been proposed as the driver of a one-plume convection pattern, with consequence for the formation of the Tharsis buldge during the early eons [*Harder and Christensen*, 1996]. A determination of the core size and better constraints on the temperature of the core-mantle boundary will allow therefore to precise if a geodynamical evolution of Mars with an initial hot mantle with such discontinuity was ever possible and if the vanishing of this discontinuity with the mantle secular cooling might have influenced the planetary evolution.

Seismology will be therefore mandatory in order to improve our knowledge on the Martian structure and our understanding of its evolution. Let us consider the different existing models proposed for the Mars mantle, shown in Figure 10 and address the variability of the different seismological observations. The simplest seismological secondary data, which can be extracted from seismic data are the travel times of P and S waves (in the sort period range, 0.1-5Hz for remote events), the group and phase velocities of surface waves (in the long period range, 10mHz-0.1 Hz) and the frequencies of the fundamental spheroidal modes. These observable are shown on Figure 11 and differences of several 10 of pourcents can be observed among these models. Such zero order differences will be easily constrained as soon as seismic signal are successfully recorded. We detail therefore in the following section the apriori on seismic signal, noise and propagation properties on Mars and estimate the prospects of a future seismic experiment on this planet.

### Seismic activity and seismic noise

A mission deploying a single or two VBB seismometers has been never successfully performed on Mars, leaving the seismic activity and the seismic noise of the planet unknown. If wind-generated noises were indeed the main source of external noise during the Viking Seismic experiment [Anderson *et al.*, 1977], such noises were clearly related to the vibrations of the lander in the wind [see Lognonné and Mosser [1993] for a detailed explanation]. But during the now windy periods however, the seismometer was unable to resolve the local micro-seismic noise and we can therefore expect quite low noise level [Nakamura and Anderson, 1979].

For the seismic activity, in addition to meteorite impacts [Davis, 1993], we expect natural quake related at least to the thermoelastic cooling of the lithosphere. Estimates by Golombek *et al.* [1992] from surface fault observations and by Philipps *et al.* [1991] from a theoretical estimate of the thermo-elastic cooling of the lithosphere provide some idea on the seismic activity. It is found 100 times greater than the shallow moonquake activity detected by the Apollo seismometers. But amplitudes of the largest Mars seismic signals will still be about 4 orders of magnitude (about 2.5  $M_s$  magnitude) lower than those of the largest earthquake at long periods, i.e. at frequencies below the source cutoff of the largest quakes. More in detail, the Martian activity might provide about 50 quakes of seismic moment  $10^{15}$  Nm per year, with an increase/decrease of the frequency by 5 for a decrease/increase of the seismic moment by 10, which represents a seismic activity releasing of  $10^{18}$ - $10^{19}$  Nm per year. The distribution of this seismic activity has been studied in more details by Oberst *et al.* [2004] With a total of about 7000 faults with a cumulated length of 600,000 km found, they confirmed the higher seismic activity of Tharsis.

The Martian noise has been estimated by Lognonné and Mosser [1993] for the wind generated noise, and by van Hoolst *et al.* [2003] for the temperature generated noise. Typical estimate for the ground accelerations produced by the direct deformation of the Martian surface by the wind pressure fluctuation could have peak to peak amplitudes of the order of  $10^{-9}$   $m/s^2$  in the range of 0.1 to 0.01 Hz during relatively calm conditions with

wind speed of the order of 4 m/s [Lognonné and Mosser, 1993]. Moreover, Lognonné *et al.* [1996] has shown that even on the Earth, seismometer can reach such noise level in quiet site, if protected by a light windshield. In contrast to the Viking case, the temperature variations might therefore be the major source of noise for surface installed VBB seismometers. However, as shown by van Hoolst *et al.* [2003], most of the temperature variations on Mars are associated to the daily cycle and can be approximated by a Fourier series with the fundamental (of 24h56min) and its harmonics. Moreover, thermal insulation of space qualified seismometers can reach time constant of about 4 hours and will reduce therefore the temperature variations by a factor of about 15 at 1mHz, and about 150 at 10 mHz, leading to temperature fluctuations smaller than a fraction of degree in the seismic band. An installation with a noise comparable to the Earth Low noise model (e.g. about  $10^{-9}$  m/s<sup>2</sup>/Hz<sup>1/2</sup> in the seismic bandwidth) is therefore a realistic challenge especially if an environmental correction performed through a recording of the pressure and temperature data is possible [e.g. *Beauduin et al.*, 1996].

### Normal Modes Excitation

While the extraction of internal structure information with the direct body waves will need a precise localization of the events and therefore at least 3 stations for travel times analysis (6 secondary data enabling the determination of the 4 sources parameters and of two mean mantle velocities), surface waves, normal modes and tidal analysis have the potential to provide useful information on the interior with less stations. See a series of papers for the sensitivity of normal modes to the Martian interior structure [*Bolt and Derr*, 1969, *Okal and Anderson*, 1978, *Lognonné et al.*, 1996, *Gudkova and Zharkov*, 1996a, 1996b]. We develop here these perspectives, important if the future missions deploy only a single or two seismometers on the Martian surface for long periods.

A Martian activity releasing a cumulated activity of  $10^{18}$ - $10^{19}$  Nm per year leaves statistically indeed the possibility to detect large quakes if the monitoring is performed during one or more Martian year. The excitation of normal modes by such quakes was studied by *Lognonné et al.* [1996] and later by *Gudkova and Zharkov* [2004] who both concluded that the observation of normal modes between 5 mHz and 20 mHz will be possible with a noise level of  $10^{-9}$  ms<sup>-2</sup>/Hz<sup>1/2</sup> by stacking methods on quakes with a cumulative  $10^{18}$  Nm moment or by single record analysis of the greatest quakes [Figure 7c]. The observation of normal modes below 5 mHz will be more challenging with such quakes and the search for continuous excitation of normal modes by the atmosphere is a possible alternative. Originally proposed by *Kobayashi & Nishida* [1998], the expected amplitudes are by a factor 2-3 smaller than the Earth values, and therefore typically a fraction of nanogals [*Lognonné et al.*, 2000, *Tanimoto*, 2001]. These early studies however have not fully taken the properties of the atmosphere into account. A first improved analysis was performed by *Suda et al.* [2002] by using Pathfinder data and provided very low amplitude for the excitation, typically of the order of  $3 \times 10^{-10}$  ms<sup>-2</sup>/Hz<sup>1/2</sup> for a correlation length of about 2 km for the atmospheric turbulences. Only correlation

length of 10km or more could lead to observable signals. A second estimation, unpublished by the author, estimated the continuous and more coherent (on large scale) excitation associated to the atmospheric global circulation winds and pressure using an explicit computation of the pressure glut [Lognonné *et al.*, 1994] and with global circulation models [Forget *et al.*, 1999]. Figure 12a shows for example the sensitivity kernel of the excitation term related to the pressure field, at a given local time and for a classical GCM model, for which large excitations are observed including along atmospheric fronts in the south hemisphere. After integration, such models provide the acceleration amplitudes of the modes [Figure 12b]. These estimates are however probably a minimum value due to missing small scales in GCM models. They show that significant excitation by the atmospheric global circulation. The latter being much more coherent days after days than turbulences, we can expect an increase of signal by stacking methods, if long duration measurements are available. Even if the search of the continuous excitation will be therefore challenging, it might open exiting perspectives for the detection of the lowest angular orders Normal Modes

### Surface waves

At higher frequencies and in the band 5mHz-50 mHz, surface waves analysis could also be performed for the large quakes, including in the limited case of a two stations network equipped with 3 axis seismometers and therefore able to determine the back-azimuth of surface waves. Figure 20 shows that errors in the relative epicentral distance of less than 2.5% can be achieved over a wide equatorial band of the planet ( $\pm 20^\circ$  latitude), for two typical landing sites around the Tharsis Buldge, when back-azimuth errors of  $15^\circ$  are assumed. Such measurements could constrain the major differences of the already proposed models of the mantle but it will be limited by the sensitivity of surface waves azimuth with respect to lateral variation and therefore unable to get the precision necessary to smaller differences, such as those related to the FeO content in the mantle [Mocquet *et al.*, 1996]. On the Earth, the latter indeed can reach typically  $10^\circ$  and very likely, the relatively larger crustal variations on Mars will lead to larger effects [Larmat *et al.*, 2002]. However, as observed on the Earth, a large part of the lateral variations of surface waves can be modeled with a priori on the lithosphere and upper mantle [Nataf & Ricard, 1996]. With the increasing constraints on the crustal and lithosphere thickness [e.g. Zuber *et al.*, 2000, Zuber, 2001, Wieczoreck and Zuber, 2004] and crustal heating, we can expect future development for the simulation of surface waves in complex a priori 3D crustal models of Mars.

### Body Waves Detection

The main limitation for body waves detection on Mars will be related to attenuation and to the scattering in the crust due to the impacting history, especially in the southern hemisphere highlands. The importance of attenuation on Mars was originally pointed out by Goins and Lazarewicz [1979], who have shown that the Viking seismometer with a 4 Hz central frequency was unable to detect remote events due to attenuation. Low Q

factors of the Martian mantle are indeed supported by the high secular acceleration of Phobos which is explained by a shear quality factor of about 100 at the tidal period of Phobos and of about 200 in the seismic band [Lognonné & Mosser, 1993, Zharkov and Gudkova, 1997] for liquid core models. These values can be compared to the Earth, where body waves are mainly attenuated in the Earth upper mantle ( $Q_{\mu}=150$ ) and encounter a small attenuation in the lower mantle ( $Q_{\mu}=300$ , Anderson and Dziewonski, 1981). For 5 km/s S waves, this gives a Q-cycle of 1000km at 1 Hz, and only 250 km at 4 Hz. More in details, the amplitudes of body waves are plotted by Figure 13a-b, after Mocquet, 1998. The amplitudes are computed for two frequency bands (0.1-1 Hz, 0.5-2.5 Hz) and for a near surface and isotropic source with a seismic moment of  $10^{15}$  Nm. The crustal transmission is taken into account, as well as the geometrical spreading and attenuation for a Mars model compatible with the present a-priori knowledge.

The amplitudes at frequencies higher than 0.5 Hz (0.5-2.5 Hz) decrease strongly with epicentral distance. P waves in the frequency band 0.1-1 Hz are less sensitive. This frequency bandwidth was chosen for the Optimism seismometer onboard the lost Mars96 mission (with a 1 ng resolution in that bandwidth). At higher frequencies however (0.5-2.5 Hz bandwidth), amplitudes are decreasing rapidly with the distance and for S waves, are even below the longer periods amplitudes. Moreover, scattering could be strong at such frequencies. For shallow quakes it will reduce the amplitude of the P waves during the downward propagation from the crust to the mantle, near the source, and a second time during the upward propagation, from the mantle to the surface near the receiver. The effect can lead to a reduction by 10 of the P wave energy and more for the amplitudes due to the length of the coda. Body waves below a frequency of 1Hz are therefore best adapted to the detection of marsquakes. Assuming total detection for signals with accelerations greater than  $10^{-8}$  m.s<sup>-2</sup> peak-to-peak, Mocquet [1998] has shown that 60% of quakes with seismic moment greater than  $10^{14}$  Nm, i.e., corresponding to Earth magnitude greater than 3.2 can be detected by a 4 station network. This might provide about 100 detected quakes out from the 140 quakes that are expected in one Martian year of Network operation.

## INSTRUMENTATION AND PLANNED MISSIONS

We focus here on the mission and instrument under development. For a review on the planetary seismometers developed before 1990, see Lognonné and Mosser [1993]. Since 1990, the development of new seismometers was done mainly for the Moon, with the Lunar A two axis seismometer [Mizutani et al., 1995, 2002] and for Mars, with the Mars 96 Optimism vertical axis seismometer [Lognonné et al., 1996] and with the Mars Ultra-broad band seismic package [Lognonné et al., 1996] developed for future network mission. The latter is based on two axis VBB seismometers [Lognonné et al., 2000] and on 3 axis short period micro-seismometer [Banerdt and Pike, 2001] and can be also adapted to a Lunar mission, by a change of the spring. Table 2 provides the main characteristics and performances of the sensors while Figures 14a-d show the sensors.



Lunar-A [Mizutani *et al.*, 1995, 2002], the only remaining mission in planetary seismology in development, will be launched probably in 2005 and will deploy 2 penetrators equipped with two axis seismometers. The first landing site will be close from the Apollo 12, while the other will be at the antipode. Seismic signals will be detected by a LTA/STA detection algorithm and stored in the penetrator for telemetry through the Lunar-A orbiter during one year. Due to the continuous activity of the deep moonquake, these two penetrators, as well as any future lunar seismic package, will be able to be operated in a virtual Apollo Post-Apollo network: for each deep moonquake, the Apollo station will indeed provide 8 arrival times, while the two penetrator will add 4 new arrival times. After estimation of the position and of the two source times, this will almost double the number of data available for internal structure studies from 4 (8-4) to 7 (12-5).

## SUMMARY AND NEW POSSIBLE FUTURE MISSIONS

- **Moon:** The Apollo Seismic network was unable to determine the deep interior of the Moon and does not provided detailed models of the crust and Moon mantle. Stable velocities are found mainly for the upper mantle and recent estimations of the crustal thickness (35-45km) differs from the previous ones (60-70km). While all models show a pyroxenite upper mantle, a more primordial lower mantle is tentatively proposed, with higher Mg#. We are therefore expecting Lunar A to not only constrain the size of the core by direct seismic observations but to also greatly improve the mantle velocity models. Next step will be a network of VBB seismometers on the Moon [Neal *et al.*, 2004] for future high resolution seismic exploration of the Lunar 3D internal structure.

- **Mars :** Internal structure of Mars will remain unconstrained before the deployment of seismometers by future missions [Lognonné *et al.*, 2003]. Scientific objectives have been identified, for single station pathfinder observation [Lognonné and Banerdt, Banerdt and Lognonné, 2003], for two stations performing subsurface cryolithosphere exploration [Grimm, 2003] or for a network mission such as the Netlander mission [Lognonné *et al.*, 2000, Dehant *et al.*, 2004]. Such missions need an implementation in the future international opportunities.

- **Jovian and Saturnian satellites :** The exploration of the outer planet has revealed the complexity of the internal structure of the giant planets satellites. See Kuskov and Kronrod [2001], Sohl *et al.* [2002] for a recent review on their interior. Of special interest for future seismic studies will be the Jovian satellite Europa [e.g. Carr *et al.*, 1998] and the saturnian one Titan [e.g. Grasset *et al.*, 2000, Sohl *et al.*, 2003], in both of which an ocean covered by a icy crust, is probable. Kovach *et al.* [2001] and Lee *et al* [2003] have studied in more detail the possibilities of seismic exploration of Europa. They have shown that a passive seismic experiment will be able to detect natural sources, either related to ice cracking, to tidal induced quakes and to natural impacts and that the recording of ice shell trapped surface waves in the frequency band

0.1-10Hz will allow the determination of the thickness of the solid ice crust.

• **Venus** : Some estimation of the seismicity activity, done for the past NASA Venus Internal Structure Mission study [*Stofan et al.*, 1993] suggested a seismic active planet. With a seismogenic layer of 30 km, more than 100 and about 25 quakes of  $M_s$  greater than 5, respectively 6, could be released by an intra-plate activity with a strain rate of  $10^{-19} \text{ sec}^{-1}$ . Instead of deploying a seismic network designed to survive to the surface temperature of the planet (500C), *Lognonné et al.* [2003] proposed to use the coupling between the solid planet and its atmosphere. As shown by *Lognonné et al.* [1998], a significant coupling is found on the Earth and has been used for the detection of seismic waves in the ionosphere [*Ducic et al.*, 2003, *Artru et al.*, 2004]. On Venus, the coupling will be stronger due to the better acoustic adaptation of the atmosphere with respect to the interior. The surface pressure (90 bars), density ( $60 \text{ kg/m}^3$ ) and acoustic velocities (410 m/s) provide a ground impedance ( $\rho c$ ) about 60 greater than on Earth. Moreover, an additional amplification is achieved by the propagation of the wave from the surface to the 1 bar level, resulting in effects about 500 larger than on Earth when the wave reach altitudes with similar densities. The Venus Express mission will therefore search, with its VIRTIS instrument, for atmospheric temperature anomalies related to the release of seismic energy [*Marinangeli et al.*, 2004]

#### ACKNOWLEDGMENT

I would like to thank B.Banerdt, H.Mizutani, T.Spohn, C.Sotin and D.Giardini for their active support in planetary seismology and for constructive discussions during the last years. This work was partially supported by CNES and IUF grant. Many recent papers reviewed here, as well as this review, were supported by the EC MAGE Training Network, under contract RTN2- 2001-00414, MAGE. This is IPGP contribution xxx.

## REFERENCE

- Anderson, D. L., W. F. Miller, G. V. Latham, Y. Nakamura, M. N. Toksoz, A. M. Dainty, F. K. Duennebie, A. R. Lazarewicz, R. L. Kowach and T. C. Knight, 1977.. Seismology on Mars, *J. Geophys. Res.*, 82:4524-4546,
- Artru, J., T. Farges, P. Lognonné, Acoustic waves generated from seismic surface waves: propagation properties determined from Doppler sounding observation and normal-modes modeling. 2004. *Geophys. J. Int.*, in press.
- Banerdt B., Chicarro A.F., M. Coradini, F. Federico, R. Greeley, M. Hechler, J.M. Knudsen, C. Leovy, P. Lognonné, L. Lowry, D. Mc Cleese, C. McKay, R. Pellinen, R. Philipps, G.E.N. Scoon, T. Spohn S. Squyres, F. Taylor and H. Wänke, 1996.. InterMarsnet, Phase A study report, *ESA Pub*, SCI(96)2.
- Banerdt, W. B.; Pike, W. T. 2001. A Miniaturized Seismometer for Subsurface Probing on Mars, Conference on the Geophysical Detection of Subsurface Water on Mars, August 6-10, 2001, Houston, Texas, abstract no.7056
- Banerdt, W. B.; Lognonné, , 2003. An Autonomous Instrument Package for Providing "Pathfinder" Network Measurements on the Surface of Mars Authors, Sixth International Conference on Mars, July 20-25 2003, Pasadena, California, abstract no.3221
- Beauduin, R., P. Lognonné, J.P. Montagner, S.Cacho, J.F. Karczewski and M. Morand, The effect of the atmospheric pressure changes on seismic signals or how to improve the quality of a station, *Bull. Seism. Soc. Am.*, 86 :1760-1769, 1996.
- Bills, B.G. and A.J. Ferrari, 1977. A lunar density consistent with topographic, gravitational, librational and seismic data, *J. Geophys. Res.*, 82 :1306-1314.
- Bills, Bruce G.; Rubincam, David P., 1995. Constraints on density models from radial moments: Applications to Earth, Moon, and Mars, *J. Geophys. Res.*, 100:26305-26316.
- Bolt, B.A. and J.S. Derr, 1969. Free bodily vibrations of the Terrestrial planets, *Vistas in Ast.*, 11:69-102,
- Buck, W. R.; Toksoz, M. N., 1980. The bulk composition of the moon based on geophysical constraints, Proc. Lunar and Planetary Science Conference, 11th, 3:2043-2058.
- Butler C., France purges Space programme in bid to survive budget crisis, 2003. *Nature*, 423 :103.
- Carr, M.H.; Belton, M. J. S.; Chapman, C.R.; Davies, M.E.; Geissler, P.; Greenberg, R.; McEwen, A.S.; Tufts, B.R.; Greeley, R.; Sullivan, R., 1998. Evidence for a subsurface ocean on Europa, *Nature*, 391 :363.
- Chenet, H., J. Gagnepain-Beyneix, P. Lognonné and L. Vinnik, 2000. Reprocessing of the Apollo Lunar Seismic Data: A thinner Lunar Crust, *EOS Transaction AGU*, 81 :F771 (Abst.)
- Chicarro A.F., M. Coradini, M. Fulchignoni, I. Liede, P. Lognonné, J.M. Knudsen, G.E.N. Scoon and H. Wänke, 1991. Marsnet, Assesment Study Report, *ESA Pub.*, SCI(91)6.
- Chicarro A.F., M. Coradini, M. Fulchignoni, K. Hiller, J.M. Knudsen, I. Liede, C. Lindberg, P. Lognonné, R. Pellinen, T. Spohn, F. Taylor, G.E.N. Scoon and H. Wänke, 1993. Marsnet, Phase A Study Report, *ESA Pub.*, SCI(93)2.
- Chenet, H., J. Gagnepain-Beyneix, P. Lognonné and L. Vinnik, 2000. Reprocessing of the Apollo Lunar Seismic Data: A thinner Lunar Crust, *EOS Transaction AGU*, 81:F771 (Abstr.)
- Chenet H., 2003. Etude de la structure interne de la Lune, PhD Thesis, IPGP Univ Paris VII, . [http://tel.ccsd.cnrs.fr/documents/archives0/00/00/58/39/index\\_fr.html](http://tel.ccsd.cnrs.fr/documents/archives0/00/00/58/39/index_fr.html)
- Chenet H., P. Lognonné, M.A. Wiczeorek and H. Mizutani, 2004. A first crustal thickness map of the moon with apollo seismic data, *Lun. Planet. Sci. Conf*, 35th, (Abstr.)

- Cooper M. R., R. L. Kovach and J. S. Watkins, 1974. Lunar near surface structure, *Rev. Geophys. Space Phys.*, 12:291-308,
- Dainty, A.M., M.N. Toksoz, K.R. Anderson, P.J. Pines, Y. Nakamura, and G. Latham, 1974. Seismic scattering and shallow structure of the Moon in Oceanus Procellarum, *Moon*, 9 :11-29.
- Davis, P. M.,1993. Meteoroid Impacts as Seismic Sources on Mars, *Icarus*, 105:469-478
- V.Dehant, P.Lognonné and C. Sotin, 2004. Netlander: a European mission to study the planet Mars, in press, *Plan. Space. Sciences*.
- Dreibus, G., Wanke, H., 1985. A volatile-rich planet, *Meteoritics*, 20:367–382.
- Ducic, V., J. Artru and P. Lognonné, 2003. Ionospheric remote sensing of the Denali Earthquake Rayleigh surface waves, *Geophys. Res. Lett.*, doi:10.1029/2003GL017812.
- Dziewonski, A.M.; Anderson, D.L., 1981. Preliminary reference Earth model, *Physics Earth and Planet. Int.*, 25:297-356.
- Forget, F.; Hourdin, F.; Fournier, R.; Hourdin, C.; Talagrand, O.; Collins, M. Lewis, S. R.; Read, P. L.; Huot, J-P, , 1999. Improved general circulation models of the Martian atmosphere from the surface to above 80 km, *Journal of Geophys. Res.*, 104:24155-24176
- Gagnepain-Beyneix, J. T.Gabsi, P.Dayre and P.Lognonné, 2002. Apollo Seismic data in mini-seed, <http://ganymede.ipgp.jussieu.fr/GB/donnees/>
- Gagnepain-Beyneix, J., P. Lognonné, H.Chenet, T. Spohn, 2004. Seismic model of the Moon and their constrains on the mantle temperature and mineralogy, submitted, *Phys. Earth Planet Int.*
- Goins, N. R.; Dainty, A. M.; Toksoz, M. N, 1981a. Seismic energy release of the moon, *J. Geophys. Res.*, 86 :378-388.
- Goins, N.R. , A.M. Dainty and N. Toksoz, 1981a. Structure of the Lunar highlands site Apollo 16, *Geophys. Res. Lett.*, 8:29-32.
- Goins N.R., A.M. Dainty and M.N. Toksoz, 1981b. Lunar seismology: The internal structure of the Moon, *J. Geophys. Res.*, 86 :5061-5074.
- Goins N.R., and A.R. Lazarewicz, 1979. Martian seismicity, *Geophys. Res. Lett.*, 6:368-370.
- Golombek, M.P., W.B. Banerdt, K. L. Tanaka, and D.M. Tralli, 1992. A prediction of Mars seismicity from surface faulting, *Science*, 258:979-981.
- Grasset, O.; Sotin, C.; Deschamps, F., 2000. On the internal structure and dynamics of Titan, *Planetary and Space Science*, 48:617-636.
- Grimm, R. E., 2002 ; The Naiades: A Mars Scout Proposal for Electromagnetic and Seismic Groundwater Exploration, American Geophysical Union, Fall Meeting 2002, abstract #P12A-0368.
- Gudkova T. V. and V. N. Zharkov, 1996a. The exploration of Martian interiors using the spheroidal oscillation Method, *Planet. Space Sci.*, 44 :1223-1230.
- Gudkova T. V. and V. N. Zharkov, 1996b. On investigation of Martian crust structure using the free oscillation method, *Planet. Space Sci.*, 44 :1231-1236
- Gudkova, T.V. and V.N. Zharkov, 2004. Mars: interior structure and excitation of free oscillations, *Phys. Earth and Plan. Int.*, 142:1–22.
- Gudkova, T.V. and V.N. Zharkov, 2002. The exploration of the lunar interior using torsional oscillations, *Planet. and Space Sci.* 50 :1037 – 1048.
- Harder H. and U.R.Christensen,1996. A one plume model of martian mantle convection, *Nature*, 380:507-509.
- Hillgren, V.J., C.K.Gessmann and J.LI, 2000. An experimental perspective on the light element in Earth's core, in *Origin of the Earth and Moon*, R.M.Canup, K. Righter editors, Univ. Arizona Press, Tucson, 245-264.

Hood, L.L., 1986. Geophysical constraints on the lunar interior, in origin of the Moon (W.K.Hartmann, R.J.Phillips and G.J.Taylor, eds), pp361-410, Lunar and Planetary Institute, Houston.

Hood, L.L. and J.H. Jones, 1987. Geophysical constraints on lunar bulk composition and structure:a reassessment, *J. Geophys. Res.*, 92 :E396-E410.

Hood, L.L.; Mitchell, D. L.; Lin, R. P.; Acuna, M. H.; Binder, A.B., 1999. Initial measurements of the lunar induced magnetic dipole moment using Lunar Prospector magnetometer data, *Geophys. Res. Lett.*, 26:2327-2330

Hood, L.L. and M.T.Zuber, 2000. Recent refinements in geophysical constraints on lunar origin and evolution, in *Origin of the Earth and Moon* ( R.M.Canup, K.Righter ed.), The University of Arizona pres, pp397-409.

Horvath, P., G.V. Latham, Y. Nakamura and H.J. Dorman, 1980. Lunar near surface shear wave velocities at the Apollo landing sites as inferred from spectral amplitude ratios, *J. Geophys. Res.*, 85:6572-6578.

Khan, A, K. Mosegaard and K.L. Rasmussen, 2000. A new seismic velocity Model for the Moon from a Monte Carlo inversion of the Apollo Lunar Seismic Data, *Geophys. Res. Lett.*, 27 :1591-1594.

Khan A. and K. Mosegaard, 2001. New Information on the Deep Lunar Interior from an Inversion of Lunar Free Oscillation Periods, *Geophys. Res. Lett.*, 28 :1791-1794,

Khan A. and K. Mosegaard, 2002. An Inquiry into the Lunar Interior- A non-linear Inversion of the Apollo Seismic Data, *J. Geophys. Res.*, 107, 10.1029/2001JE001658,

Khan,A., K. Mosegaard, J. G. Williams and P. Lognonné, 2004. Does the Moon Possess a Molten Core? Probing the Deep Lunar Interior Using Results From LLR and Lunar Prospector, *J. Geophys. Res.*, in press.

Kobayashi, N.; Nishida, K., 1998. Atmospheric excitation of planetary free oscillations, *J. of Physics: Cond. Matter*, 10 :11557-11560

Kovach, Robert L.; Chyba, Christopher F., 2001. Seismic Detectability of a Subsurface Ocean on Europa, *Icarus*, Volume 150:279-287.

Koyama, J.; Nakamura, Y., 1979.. Re-Examination of the Lunar Seismic Velocity Structure Based on the Complete Data Set, *Abstract Lunar and Plan. Sci. Conf.*, X, 685-687.

Kuskov, O. L.; Fabrichnaya, O. B., 1994. Constitution of the Moon: 2. Composition and seismic properties of the lower mantle, *Physics Earth and Planet. Int.*, 83 :197-216.

Kuskov, O.L. , 1995. Constitution of the Moon: 3. Composition of middle mantle from seismic data, *Physics. Earth Planet. Int.*, 90:55-74.

Kuskov, O.L.,1997. Composition of the Moon:4. Composition of the mantle from seismic data, *Physics. Earth Planet. Int.*, 102 :239-257.

Kuskov O.L. and V.A. Kronrod, 1998. Constitution of the Moon 5. Constraints on composition, density, temperature and radius of a core, *Phys. Earth. Plan. Int.*, 107:285-306.

Kuskov, Oleg L.; Kronrod, Victor A. 2001. Core Sizes and Internal Structure of Earth's and Jupiter's Satellites, *Icarus*, 151:204-227.

Kuskov, O.L., V.A. Kronrod and L.L. Hood, 2002. Geochemical constraints on the seismic properties of the lunar mantle, *Phys. Earth. Plan. Int.* 134 :175-189.

Lammlin D., G.V. Latham, J. Dorman, Y. Nakamura and M. Ewing, 1974. Lunar seismicity, structure and tectonics, *Rev. Geophys. Space Phys.*, 12:1-21.

Lammlin, D., 1977. Lunar seismicity and tectonics, *Phys. Earth Planet. Inter.*,14:224-273.

Larmat, C. S., Capdeville, Y., Montagner, J., Banerdt, B., Lognonné, P., Vilotte, 2002. J.Simulation of the Effect of Topography and Crustal Thickness on the Martian Seismograms by the Coupled Method. American Geophysical Union, Fall Meeting, abstract #P62A-0367.

Larson, E.W.F and G. Ekström, 2002. Determining surface wave arrival angle anomalies, *J. Geophys. Res.*, 107, 10.1029/2000JB000048.

Latham, G., M. Ewing, F. Press and G. Sutton, 1969. The Apollo Passive Seismic Experiment, *Science*, 165 :241-250,

Latham, G. V., M. Ewing, F. Press, G. Sutton, J. Dorman, Y. Nakamura, N. Toksoz, R. Wiggins, J. Derr and F.Duennebier, 1970a. Passive seismic experiment, *Science*, 167:455-457.

Latham, G. V., M. Ewing, J. Dorman, F. Press, N. Toksoz, G. Sutton, R. Meissner, F. Duennebier, Y. Nakamura, R. Kovach and M. Yates, 1970b. Seismic data from man-made impacts on the Moon, *Science*, 170:620-626.

Latham, G.V., M. Ewing, J. Dorman, D. Lammlein, F. Press, N. Toksoz, G. Sutton, F. Duennebier, Y. Nakamura, Moonquakes, *Science*, 174 :687-692, 1971.

Lee, S; Zanolin, M; Thode, A M.; Pappalardo, R. T.; Makris, N. C., 2003. Probing Europa's interior with natural sound sources, *Icarus*, 165 :144-167.

Lehner, F.E., E.O. Witt, W.F. Miller and R.D. Gurney, 1962. A seismometer for lunar experiments, *J. Geophys. Res.*, 67:4779-4786.

Linkin, V., A.M. Harri, A. Lipatov, K. Belostotskaja, B. Derbunovich, A. Ekonomov, L. Khlostova, R. Krmenev, V. Makarov, B. Martinov, D. Nenarokov, M. Prostov, A. Pustovalov, G. Shustko, I. Jarvine., H. Kivilinna, S. Korpela, K. Kumpulainen, R. Pellinen, R. Pirjola, P. Riihela, A. Salminen, W. Schmidt, T. Siili, J. Blamont, T. Carpentier, A. Debus, C.T. Hua, J.F. Karczewski, H. Laplace, P. Levacher, P. Lognonné, C. Malique, M. Menvielle, G. Mouli, J.P. Pommereau, K. Quotb, J. Runavot, D. Vienne, F. Grunthner, F. Kuhnke, G. Mussman, R. Rieder, H. Wanke, T. Economou, M. Herring, A. Lane, C. McKay, 1998.. A sophisticated lander for scientific exploration of Mars: Scientific objectives and Implementation of the Mars96 Small Station, *Planetary Space Sciences*, 46 :717-737,

Lodders, K.; Fegley, B., 1997. An Oxygen Isotope Model for the Composition of Mars, *Icarus*, 126:373-394.

Lognonné P. & B. Mosser, 1993. Planetary Seismology, *Survey in Geophysics*, 14:239-302.

Lognonné, P, B. Mosser and F.A. Dahlen, 1994. Excitation of the Jovian seismic waves by the Shoemaker-Levy 9 cometary impact, *Icarus*, 110 :186-195.

Lognonné, P., J. Gagnepain-Beyneix, W.B. Banerdt, S.Cacho, J.F. Karczewski, M. Morand, An Ultra-Broad Band Seismometer on InterMarsnet, 1996. *Planetary Space Sciences*, 44:1237-1249.

Lognonné, P. V.N. Zharkov, J.F. Karczewski, B. Romanowicz, M. Menvielle, G. Poupinet, B. Brient, C. Cavoit, A. Desautez, B. Dole, D. Franqueville, J. Gagnepain-Beyneix, H. Richard, P. Schibler, N. Striebig, 1998a. The Seismic Optimism Experiment, *Planetary Space Sciences*, 46:739-747.

Lognonné, P., C. Clévéde and H. Kanamori, 1998b. Normal mode summation of seismograms and barograms in a spherical Earth with realistic atmosphere, *Geophys. J. Int.*, 135:388-406.

Lognonné, P., D. Giardini, B. Banerdt, J. Gagnepain-Beyneix, A. Mocquet, T. Spohn, J.F. Karczewski, P. Schibler, S. Cacho, W.T. Pike, C. Cavoit, A. Desautez, J. Pinassaud, D. Breuer, M. Campillo, P. Defraigne, V. Dehant, A. Deschamps, J. Hinderer, J.J. Lévêque, J.P. Montagner, J. Oberst, 2000. The NetLander Very Broad band seismometer, *Planet. Space Sc.*, 48 :1289-1302.

Lognonné P. and E. Clévéde, 2002. Chapter 10: Normal modes of the Earth and Planets, Handbook on Earthquake and Engineering Seismology, IASPEI Centennial Publications, H. Kanamori, P. Jennings and W. Lee editors, International Geophysics series, 81A, Academic Press.

Lognonné, P., J. Gagnepain-Beyneix and H. Chenet, 2003. A new seismic model of the Moon: implication in terms of structure, formation and evolution, *Earth Plan. Sci. Lett.*, 6637:1-18.

Lognonné, P., T. Spohn, D. Giardini, 2003. Mars in depth, *Astronomy and Astrophysics*, 44 :15.

Lognonné, Ph.; Banerdt, W. B., 2003. Rationale for Seismic Measurements on Mars by a Single Station, *Sixth International Conference on Mars*, Pasadena, Ca, abstract no.3225.

Lognonné, P., R. Garcia, B. Romanowicz and B. Banerdt, 2003. A new concept for seismology on Venus using orbiting radar instead of landers, AGU abstract, fall meeting,

Loudin, M. G.; Alexander, S. S., 1978. Observed Estimates of Spheroidal Free Oscillations of the Moon and Their Interpretation, *EOS; Trans, Amer. Geophys. Un.*, 59 :1124.

Lombardi, D., P. Lognonné, J. Gagnepain-Beyneix et T. Gudkova, 2002. Calibration des impacts naturels et artificiels sur la Lune ou Mercure, p58-59, *Colloque du programme National de Planétologie*, Nantes..

Marinangeli, L. L.; Baines, K.; Garcia, R.; Drossart, P.; Piccioni, G.; Benkhoff, J.; Helbert, J.; Langevin, Y.; Ori, G. G.; Komatsu, G.; Pope, I. C., 2004. Venus Surface Investigation Using VIRTIS Onboard the ESA/Venus Express Mission, 35th Lunar and Planetary Science Conference, League City, Texas, abstract no.1363

Mark, N.; Sutton, G. H. 1975. Lunar shear velocity structure at Apollo sites 12, 14, and 15, *J. Geophys. Res.*, 80 :4932-4938.

Mizutani, H, 1995. Lunar interior exploration by Japanese lunar penetrator mission, Lunar-A, *J. Phys. Earth*, 43:657-670.

H. Mizutani, A. Fujimura, S. Tanaka, H. Shiraishi and T. Nakajima, 2003. Lunar-A mission: Goals and status, *Advances in Space Res.*, 31:2315-2321

Mocquet, A, P. Vacher, O. Grasset and C. Sotin, 1996. Theoretical seismic models of Mars: the importance of the iron content of the mantle, *Planet. Space Sci.*, 44 :1251-1268.

Mocquet, A, 1998. A search for the minimum number of stations needed for seismic networking on Mars, 1999. *Plan. Space. Science.*, 47:397-409,

Mueller, S., Taylor, G.J., Philips, R.J., 1988. Lunar composition: a geophysical and petrological synthesis, *J. Geophys. Res.*, 93 :6338-6352.

Nakamura, Y., G. Latham, D. Lammlein, M. Ewing, F. Duennebier and J. Dorman, 1974. Deep lunar interior inferred from recent seismic data, *Geophys. Res. Lett.*, 1 :137-140.

Nakamura, Y.; Dorman, J.; Duennebier, F.; Lammlein, D.; Latham, G., 1975. Shallow lunar structure determined from the passive seismic experiment, *The Moon*, 13 :57-66.

Nakamura, Y., 1976. Seismic energy transmission in the lunar surface zone determined from signals generated by movement of lunar rovers, *Bull. Seismol. Soc. Am.*, 66 :593-606.

Nakamura, Y., 1977a. Seismic energy transmission in an intensely scattering environment, *J. Geophys. Res.*, 43:389-399.

Nakamura, Y., 1977b. HFT events - Shallow moonquakes, *Physics Earth Planet. Int.*, 14:217-223.

Nakamura, Y., 1978. A1 Moonquakes: Source distribution and mechanisms, *Proc. Lunar Sci. Conf., 9th*, pp 3589-3607.

Nakamura, Y.; Anderson, D. L., 1979. Martian wind activity detected by a seismometer at Viking lander 2 site, *Geophys. Res. Lett.*, 6:499-502.

Nakamura, Y., 1983. Seismic velocity structure of the lunar mantle, *J. Geophys. Res.*, 88 :677-686.

Nakamura, Y., 2003. New identification of deep moonquakes in the Apollo lunar seismic data, *Physics Earth Planet. Int.*, 139 :197-205.

Nakamura, Y., 2004. More Far-Side Deep Moonquake Nests Discovered, *35th Lunar and Planet Sci. Conf*, abstract no.1155

Nataf, H.; Ricard, Y., 1996. 3SMAC: an a priori tomographic model of the upper mantle based on geophysical modeling, *Physics of the Earth and Plan. Int.*, 95 :101-122.

Neal, C. R.; Banerdt, W. B.; Chenet, H.; Gagnepain-Beyneix, J.; Hood, L.; Jolliff, B.; Khan, A.; Lawrence, D. J.; Lognonné, P.; Mackwell, S.; Mendell, W.; Miller, K.; Nakamura, Y.; Schmitt, H. H.; Shearer, C. K.; Wiczeorek, M., 2004. The Lunar Seismic Network: Mission Update, Lunar and Planetary Science Conference, 35th, abstract no.2093.

Oberst, J., 1987. Unusually high stress drop associated with shallow moonquakes, *J. Geophys. Res.*, 92:1397-1405,

Oberst, J., Nakamura, Y., 1987. Distinct meteoroid families identified on the lunar seismograms, *J. of Geophys. Res.* 92 :E769-E773.

Oberst, J., Nakamura, Y., 1991. A search for clustering among the meteoroid impacts detected by the Apollo lunar seismic network, *Icarus* 91 :315-325.

Oberst J. and H. Mizutani, 2003. A new inventory of deep moonquake nests visible at Apollo 12 area, *Lunar Planet. Sci. Conf*, 33th, 1704 (Abstr.).

Oberst, J., C. Deuchler, M. Wählisch, E. Hauber, M. Knapmeyer, and T. Spohn, 2004. Where do the Mars quakes occur?, European Geosciences Union, EGU04-A-02939 (Abstr.)

Okal, E. and D.J. Anderson, 1978. Theoretical models for Mars and their seismic properties, *Icarus*, 33:514-528,

Phillips, R.J., 1991. Expected rate of marsquakes. in Scientific Rationale and Requirements for a Global Seismic Network on Mars. LPI Tech. Rept. 91-02, Lunar and Planetary Inst., Houston. pp. 35-38.

Press F., P. Buwalda and M. Neugebauer, 1960. A lunar seismic experiment, *J. Geophys. Res.*, 65:3097-3105,

Righter, K., R.J.Walker and P.H.Warren, 2000. Significance of highly siderophile elements and osmium isotopes in the Lunar and terrestrial mantles, in *Origin of the Earth and Moon* ( R.M.Canup, K.Righter ed.), The University of Arizona pres, pp291-322.

Ringwood A.E. and E. Essene, Petrogenesis of Apollo 11 basalts, internal composition and origin of the Moon, in: *Geochim. Cosmochim. Acta* 34, *Apollo 11 Lunar Sci. Conf. Proc.*, 1970, pp769-799.

Sanloup, C., A. Jambon, P. Gillet, 1999. A simple chondritic model of Mars, *Phys. Earth and Planet. Int.* 112:43-54.

Sanloup, C., F.Guyot, P.Gillet and Y.Fei, 2002. Physical properties of liquid Fe alloys at high pressure and their bearings on the nature of metallic planetary cores, *J. Geophys. Res.*, 107, doi :10.1029/2001JB000808.

Sohl, F., and T. Spohn, 1997. The interior structure of Mars: implications from SNC meteoroids. *J. Geophys. Res.*, 102 :1613-1636.

Sohl, F.; Spohn, T.; Breuer, D.; Nagel, K., 2002. Implications from Galileo Observations on the Interior Structure and Chemistry of the Galilean Satellites, *Icarus*, 157:104-119.

Sohl, F.; Hussmann, H.; Schwentker, B.; Spohn, T.; Lorenz, R. D., 2003. Interior structure models and tidal Love numbers of Titan, *J. Geophys. Res.*, 108, DOI 10.1029/2003JE002044.

Solomon S. C., D. L. Anderson, W. B. Banerdt, R. G. Butler, P. M. Davis, F. K. Duennebieer, Y. Nakamura, E. A. Okal and R. G. Phillips, Scientific rationale and requirements for a global seismic network on Mars, *LPI Tech. Rpt. 91-02*, Lunar and Planetary Institute, Houston, 51pp, 1991.

Sotin C., F. Rocard, P. Lognonné, 2000. Summary of the International Conference of Mars Exploration Program and Sample Return mission, *Planet. Space Sc.*, 48 :1143-1144.

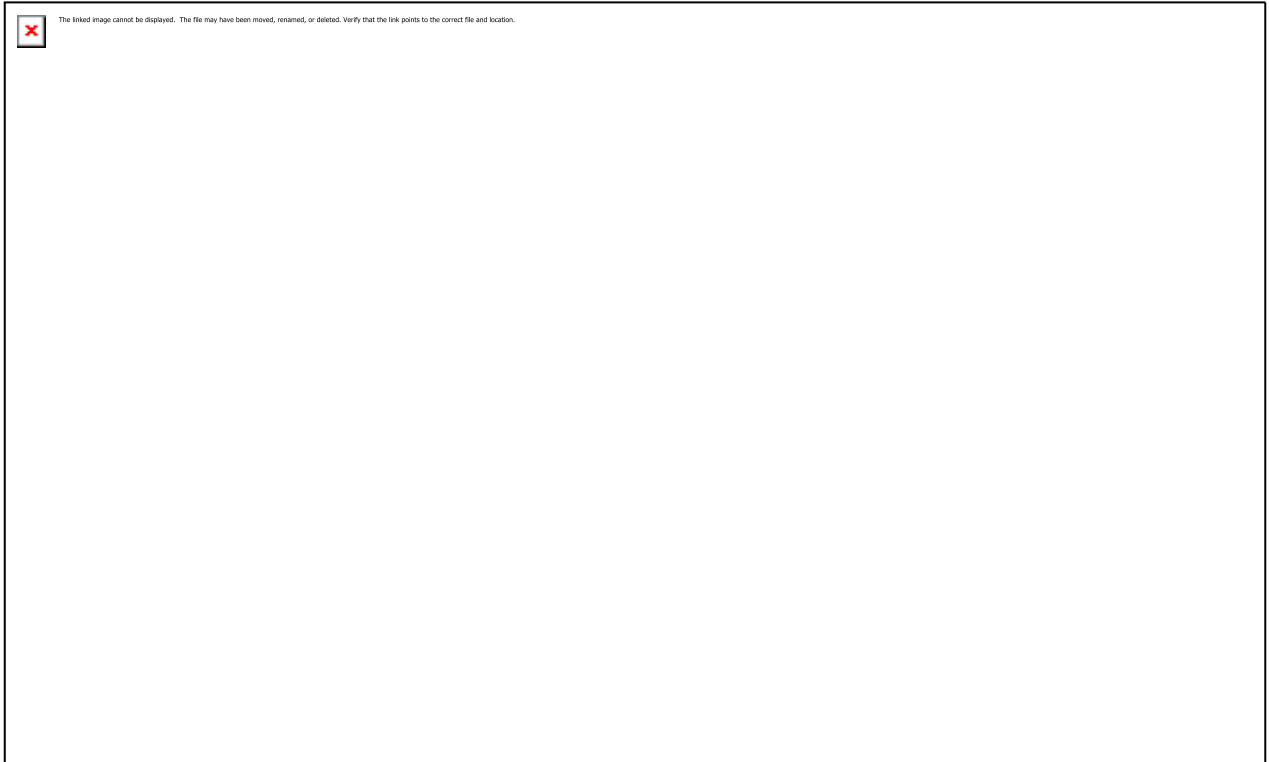


- Spohn, T., Sohl, F. and D. Breuer, 1998. Mars, *Astron. Astrophys. Rev.*, 8 :181-236.
- Stofan, E. R.; Saunders, R. S.; Senske, D.; Nock, K.; Tralli, D.; Lundgren, P.; Smrekar, S.; Banerdt, B.; Kaiser, W.; Dudenhofer, J., 1993. Venus Interior Structure Mission (VISM): Establishing a seismic network on Venus, In Lunar and Planetary Inst., Workshop on Advanced Technologies for Planetary Instruments, Part 1 p 23-24 (SEE N93-28764 11-91)
- Stevenson, D.J., 2001. Mars' core and magnetism, *Nature*, 412:214-219.
- Suda, N.; Mitani, C.; Kobayashi, N.; Nishida, K., 2002. Theoretical Calculation of Mars' Background Free Oscillations, American Geophysical Union, Fall Meeting, abstract #S12A-1186.
- Surkov, Y., 1989. Exploration of terrestrial planets from spacecraft, 390 p, page 372-373, *Ellis Horwood*, New York,
- Taylor S. R., The origin of the Moon: geochemical considerations, in *Origine of the Moon*, Lunar and Planetary Institute, W.K.Hartmann, R.J. Phillips and G.J. Taylor editors, 1984.
- Taylor, S.R., 1987. The unique lunar composition and its bearing on the origin of the Moon, *Geochim. Cosmochim. Acta*, 51 :1297-1309.
- Toksöz, M. N., Press, F.; Anderson, K.; Dainty, A.; Latham, G.; Ewing, M.; Dorman, J.; Lammlein, D.; Sutton, G.; Duennebier, F., Nakamura, Y., 1972a. Lunar crust:structure and composition, *Science*, 176 :1012-1016.
- Toksöz, M. N.; Press, F.; Anderson, K.; Dainty, A.; Latham, G.; Ewing, M.; Dorman, J.; Lammlein, D.; Nakamura, Y.; Sutton, G.; Duennebier, F., 1972b. Velocity Structure and Properties of the Lunar Crust, *Earth, Moon, and Planets*, 4 :490-504
- Toksoz, M.N., 1974. Geophysical data and the interior of the moon, *Annu. Rev. Earth Planet. Sci.*, 2 :151.
- Toksoz, M.N., Lunar and planetary seismology, 1975. *Rev. Geophys. Space Phys.*, 13 :306.
- Toksoz, M.N., 1979. Planetary seismology and interiors, *Reviews of Geophysics and Space Physics*, 17 :1641-1655.
- Toksoz, M. N., A. M. Dainty, S. C. Solomon and K. R. Anderson, 1974. Structure of the moon, *Rev. Geophys. Space Phys.*, 12 :539-567.
- Yoder, C. F.; Konopliv, A. S.; Yuan, D. N.; Standish, E. M.; Folkner, W. M., 2003. Fluid Core Size of Mars from Detection of the Solar Tide, *Science*, 300:299-303.
- Vinnick L, H. Chenet, J. Gagnepain-Beyneix, and P. Lognonné, 2001. First seismic receiver functions on the Moon, *Geophys. Res. Lett*, 28 :3031-3034.
- Van Hoolst, T., V. Dehant, F. Roosbeek and P. Lognonné, 2003. Tidally induced surface displacements, external potential variations, and gravity variations on Mars, *Icarus*, 161:281-296.
- Verhoeven, O., A. Rivoldini, P. Vacher, A. Mocquet, G. Choblet, M. Menvielle, V. Dehant, T. Van Hoolst, J. Sleewaegen, J.-P. Barriot, P. Lognonné, 2004. Planetary interiors structure inferred from electromagnetic, geodetic and seismic network science I: Forward problem on the case of Mars, submitted to *J. Geophys. Res.*
- Williams, J.G., D.H. Boogs, C.F. Yoder, J.T. Racliff and J.O. Dickey, 2001. Lunar rotational dissipation in solid body and molten core, *J. Geophys. Res.*, 106:27933-27968.
- Wieczorek, M. A.; Zuber, M. T., 2004. Thickness of the Martian crust: Improved constraints from geoid-to-topography ratios, *J. Geophys. Res.*, 109, doi:10.1029/2003JE002153.
- Zuber, M. T., 2001. The crust and mantle of Mars, *Nature*, 412:237– 244.
- Zuber, M. T., S. C. Solomon, R. J. Phillips, D. E. Smith, G. L. Tyler, O. Aharonson, G. Balmino, W.B. Banerdt, J. W. Head, C. L. Johnson, F. G. Lemoine, P. J. Mc Govern, G. A. Neumann, D. D. Rowlands, and S. Zhong, 2000. Internal structure and early thermal

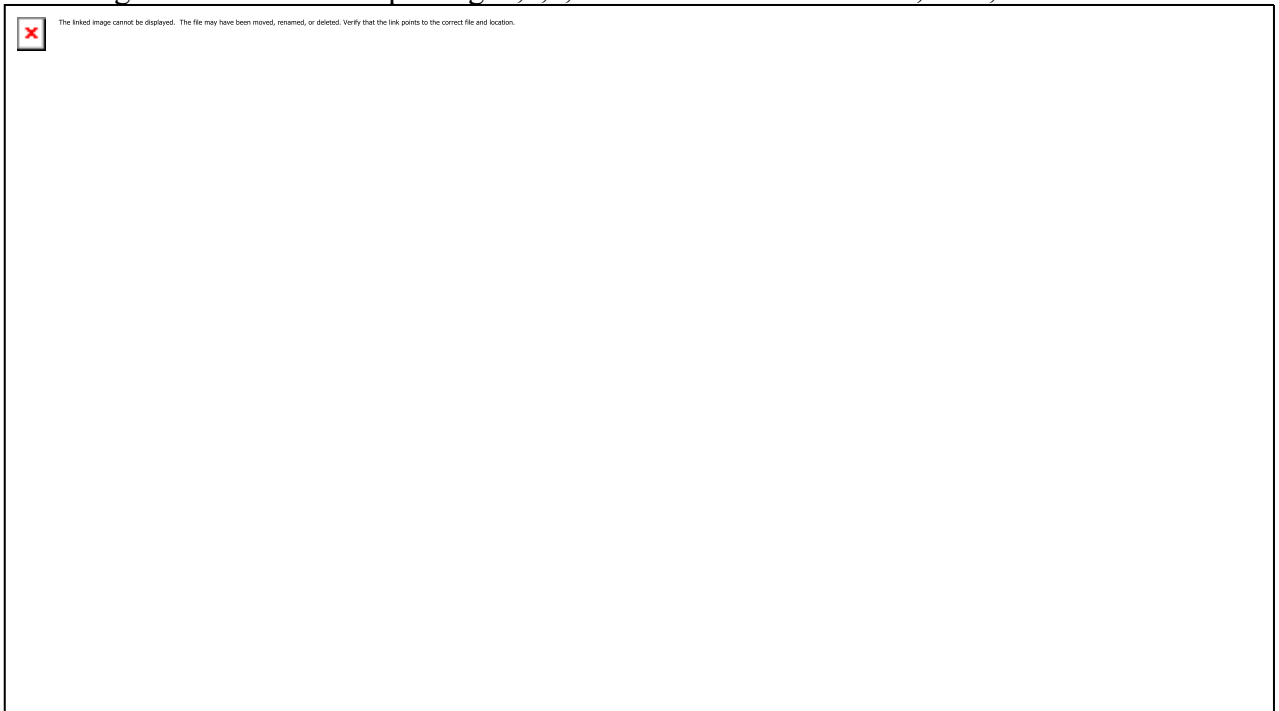
evolution of Mars from Mars Global Surveyor Topography and Gravity, *Science*, 287 :1788-1793.

Zharkov, V. N.; Gudkova, T. V., 1997. On the dissipative factor of Martian interiors, *Planet. Space Sci.*, 45, 401-407.

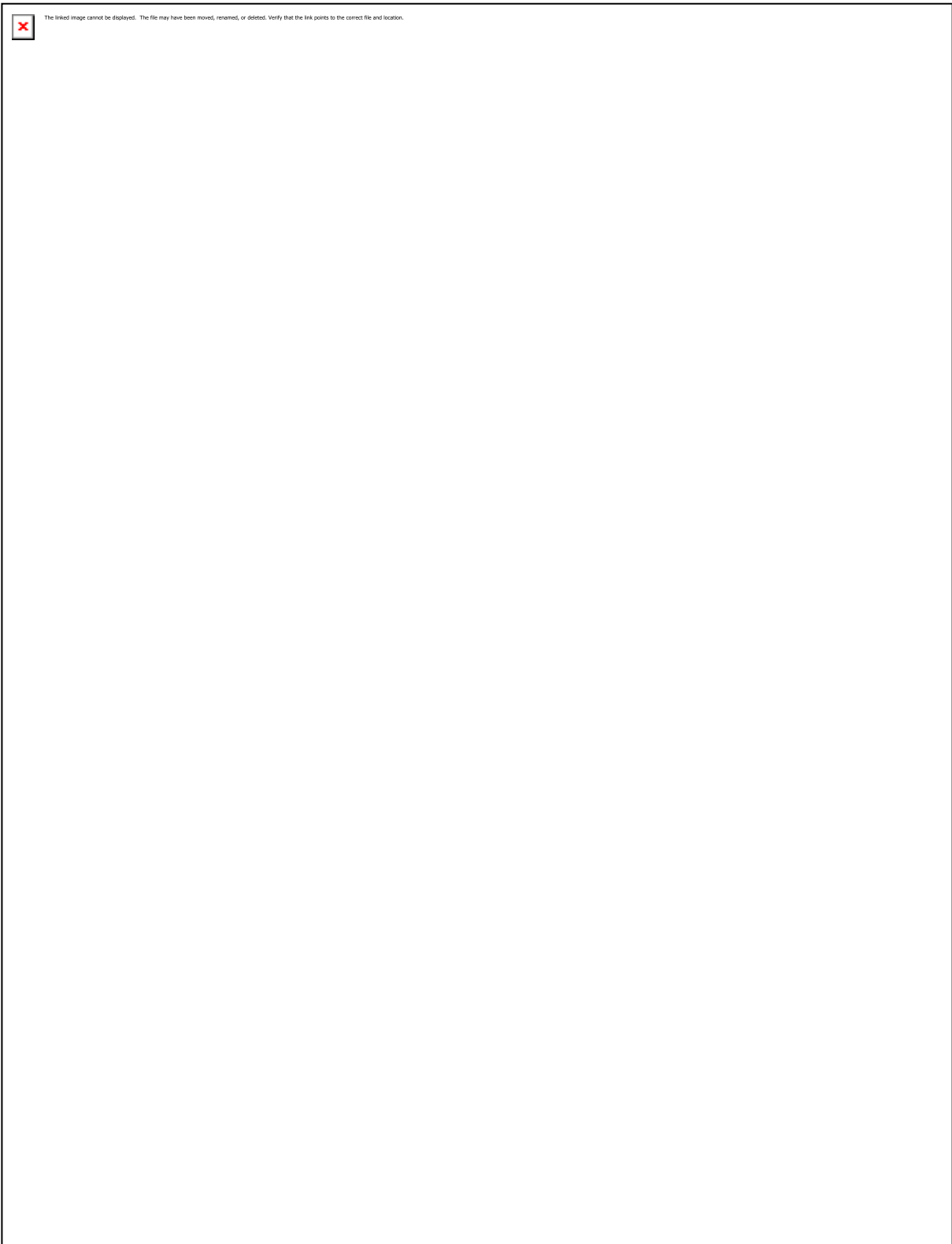
Zharkov, V. N.; Gudkova, T. V., 2000. Interior structure models, Fe/Si ratio and parameters of figure for Mars, *Physics Earth Planet. Int.*, 117:407-420



**Figure 1:** Stacked seismograms for the A42 deep Moonquake source and for all Apollo stations. Arrivals of P and S waves identified after stacking are plotted. The number is associated to the error range in the arrival time picking. 0,1,2,3 are for errors below 1sec, 3sec, 10sec and 30 sec.



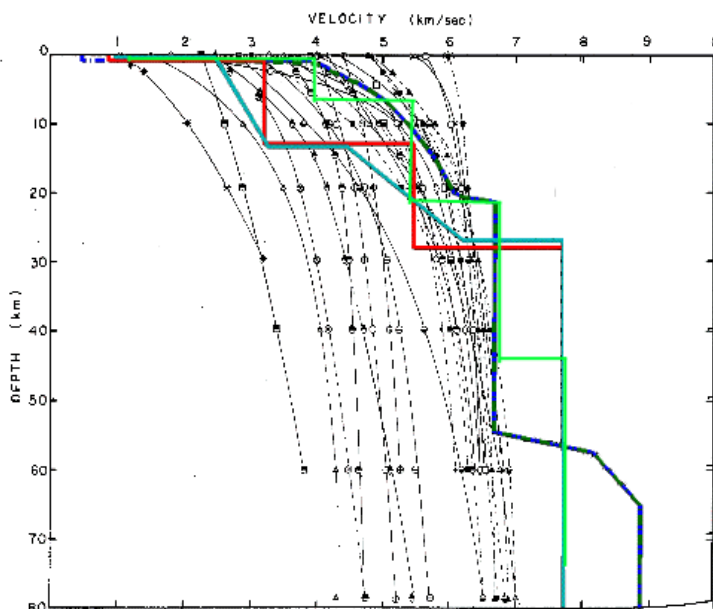
**Figure 2:** Seismic records, from the Apollo seismic network, of the impact of the Apollo 17 Saturn V upper stage (Saturn IVB) on the Moon on 10 December 1972 at distances of 338, 157, 1032 and 850 km from the Apollo 12, 14, 15 and 16 stations, respectively). X,Y,Z are for the long period seismometers, z is for the short period seismometer. Amplitudes at the Apollo 14 station, 157 km from impact, reach about  $10^{-5} \text{ m s}^{-2}$  with an amplitude mainly related to S waves trapped in the regolith. The first P arrival is typically 10 times smaller.



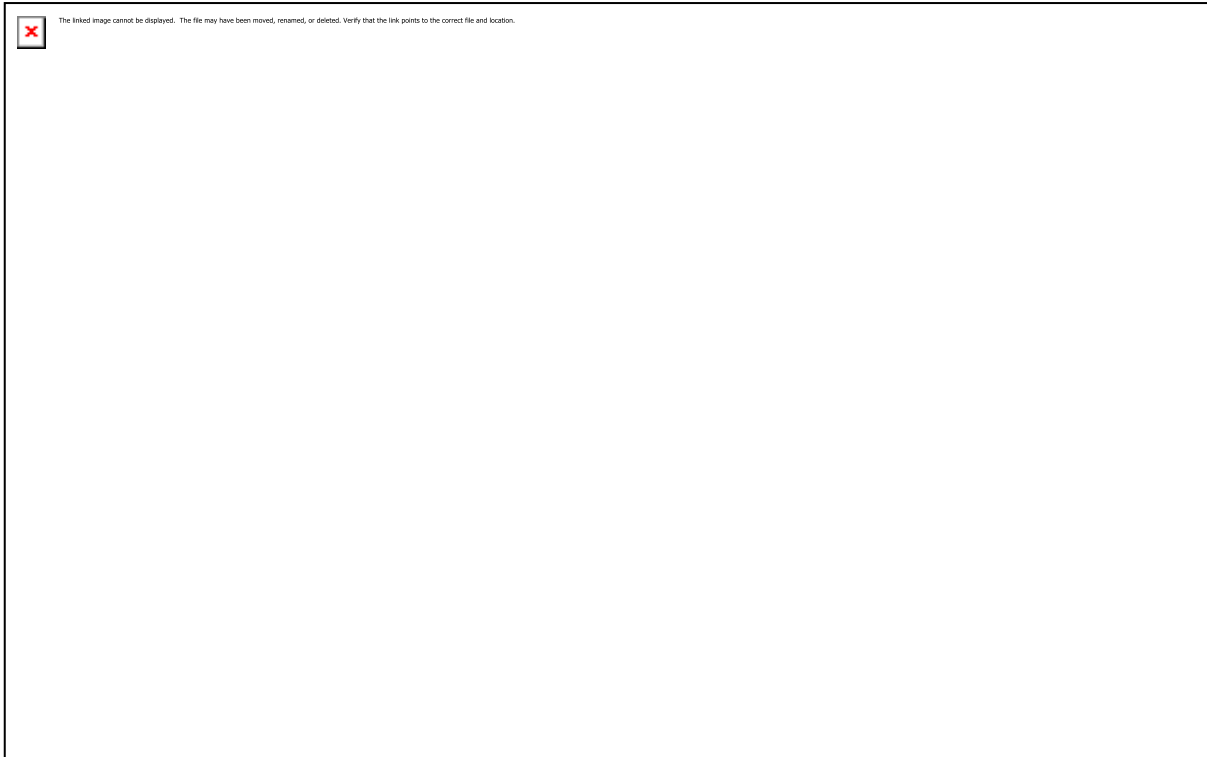
**Figure 3** : Profil of the vertical component of the meteorites impacts, as listed and used by *Lognonné et al* [2003], *Gagnepain-Beyneix et al.* [2004]. Note that a few of these events were observed at epicentral distances greater than  $90^\circ$ , including a few with more than  $120^\circ$ . Red circles are the P arrival times, and green circles are for the S arrival times. Time is in seconds.



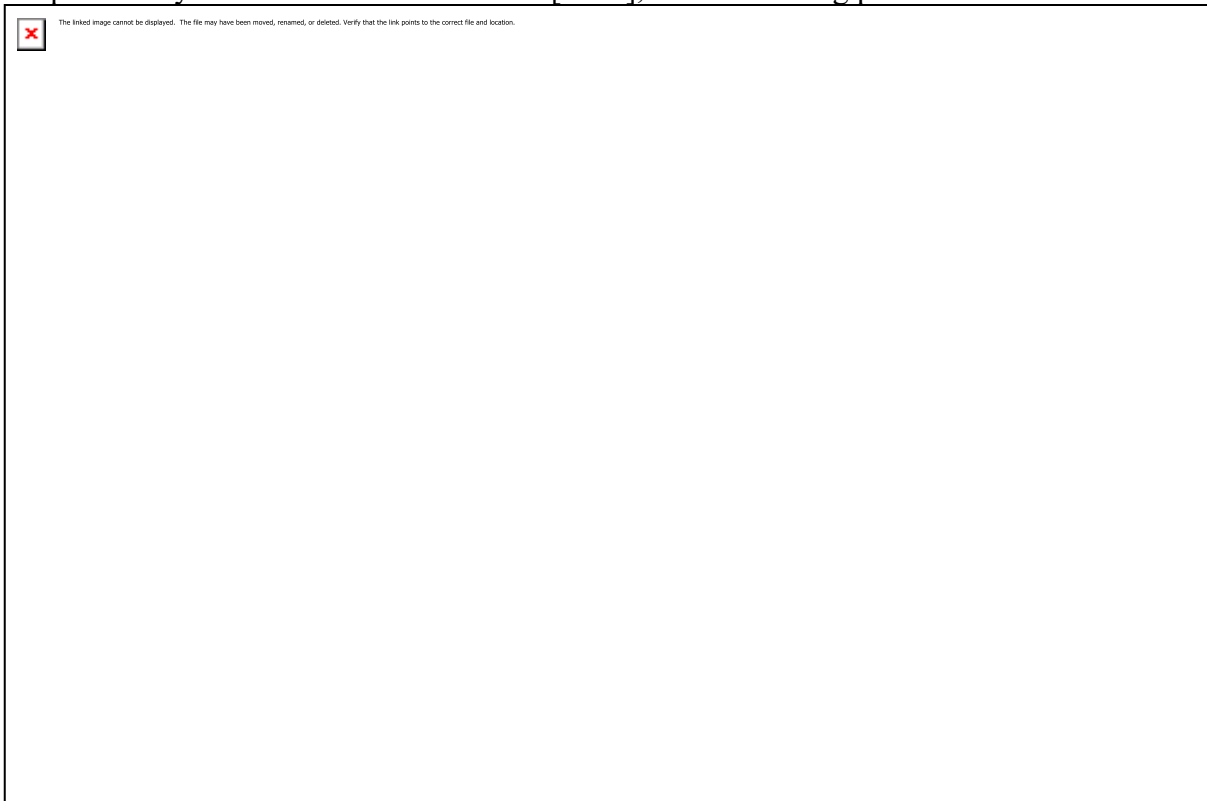
**Figure 4a:** Crustal models from *Khan and Mosegaard* [2002] for a crust in the range of  $40 \pm 5$  km (A) and in the range of  $60 \pm 10$  km (B). As seen on the figure, the model found in case A have not only a better variance reduction, but are corresponding to much better physical structures. The upper part of the crust to mantle transition for models A is located at depth of  $38 \pm 3$  km.



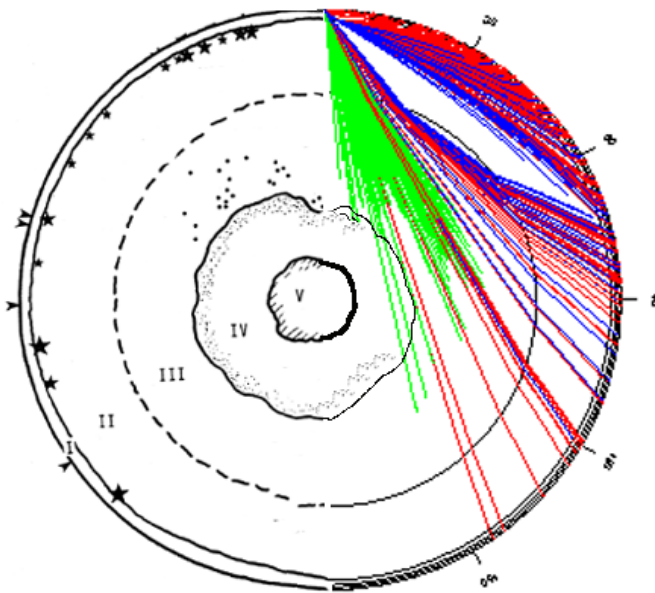
**Figure 4b:** Crustal models of *Toksöz* (dark blue line), of *Lognonné et al* [2003] (red and light blue lines) and of *Koyama and Nakamura* [1979] (green line). Crustal thicknesses are 65 km, 30 km and 45 km respectively. In background are the seismic velocities extrapolated from crustal lunar samples. *Toksöz* and *Koyama and Nakamura* velocities are high with respect to the extrapolated velocities.



**Figure 5a:** Mantle models of the Moon for P velocities. Left figure shows the layered models of *Goins et al.* [1981] (Green), *Nakamura et al.* [1983] (blue) and *Gagnepain-Beyneix et al.* [2004] (red). The grey zone is for geochemical admissible models, following *Kuskov et al.* [2002]. The dashed lines are associated to the error bars of the models. Right figure shows the probability distributions of *Khan et al.* [2002], with increasing probabilities with contours.



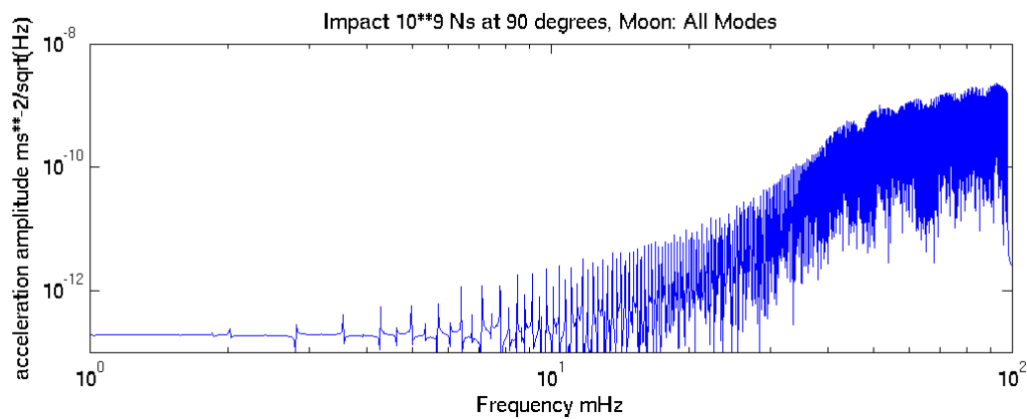
**Figure 5b:** Mantle models of the Moon for S velocities. Same convention as for the P velocities.



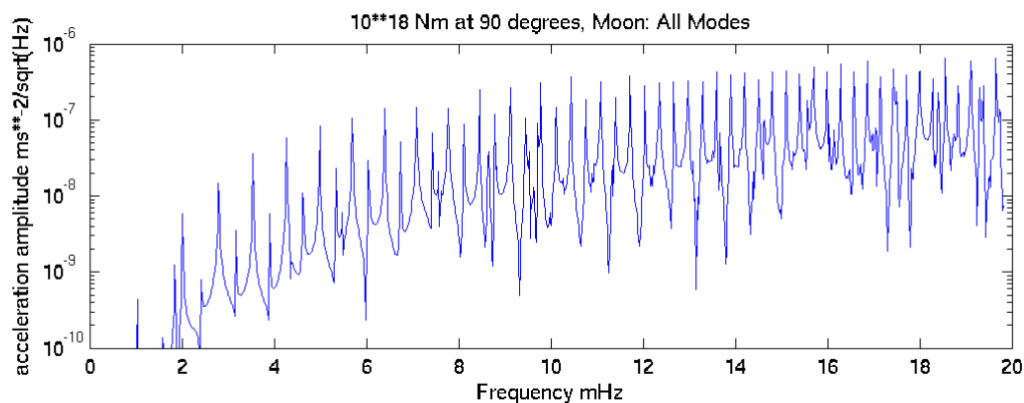
**Figure 6:** Polar view of the Moon with the repartition of the stations (square) and the deep interior structure. The stars are for the shallow moonquakes while the dot are for the deep moonquakes. Green rays, blue and red rays are respectively for the deep, shallow quakes and impact meteorites. Area I,II,III,IV and V are the crust, upper mantle, middle mantle, lower mantle and core respectively. The core is not covered by any ray and only a few propagated through the deep lower mantle.

Depth (km)	Goins et al. [1981]	Nakamura et al [1983]	Lognonné et al [2003]	Beyneix et al. [2004]	Khan et al. [2002]	Kuskov et al.[2002]
Crust-300 (1)	4.47±0.05 7.70±0.15 (5)	4.49±0.05 7.74±0.12	4.53±0.15 7.75±0.15	4.44±0.04 7.65±0.06	4.0 ±0.4 8.0 ±0.8	4.51±0.18 7.81±0.40
300-500 (2)	4.37 ±0.05 7.65±0.15 (6)	4.25 ±0.10 7.46 ±0.25	4.50±0.15 7.75±0.15	4.37±0.07 7.79±0.12	4.0 ±0.4 8.0 ±0.8	4.42±0.19 7.85±0.40
500-750 (3)	4.20±0.10 7.60±0.60	4.65 ± 0.16 8.26 ± 0.40	4.35±0.30 7.50±0.30	4.40±0.11 7.62±0.22	5.75±0.7 11.75±1.0	4.44±0.20 8.01±0.38
750-1000			4.20±0.30 7.90±0.30	4.50±0.10 8.15±0.23	(4)	

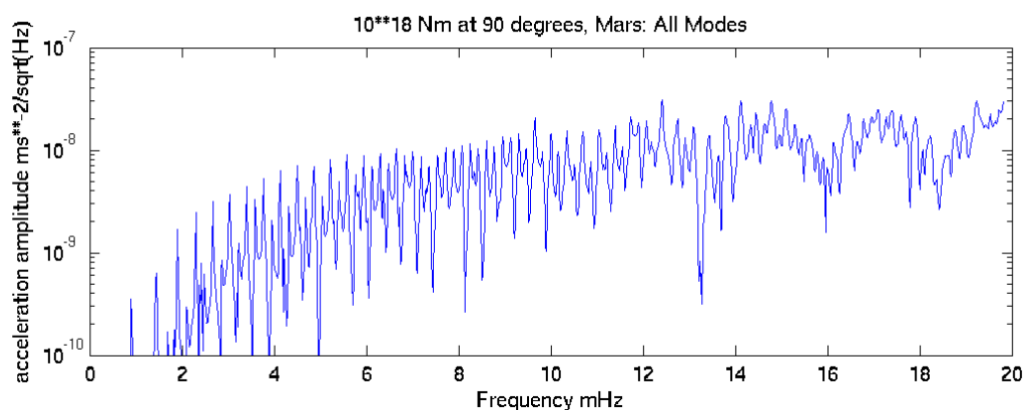
**Table 1 :** Comparison of the different seismic models of the Moon for area II, III and the top most part of IV. All seismic velocities are in km/s. (1) Depth is 270 for Nakamura et al. [1981], 238 km for Beyneix et al. [2004] (2) Maximum depth is 488 km for Beyneix et al. [2004] (3) Maximum depth is 738 km for Beyneix et al [2004] (4) No clear maximum for P velocities, except at a depth of about 800 km (5) Velocity at 230 km deep (6) velocities at 480 km deep



**Figure 7a:** Amplitude spectral density of a one day seismic signal recorded on the vertical component at an epicentral distance of  $90^\circ$ . The source is an impact source with an impulse of  $10^9$  Ns. Below 10 mHz, the amplitudes are smaller than  $2 \times 10^{-12}$   $\text{ms}^{-2}/\text{Hz}^{1/2}$ , and therefore at least 100 times smaller than the instrument noise at this frequency.

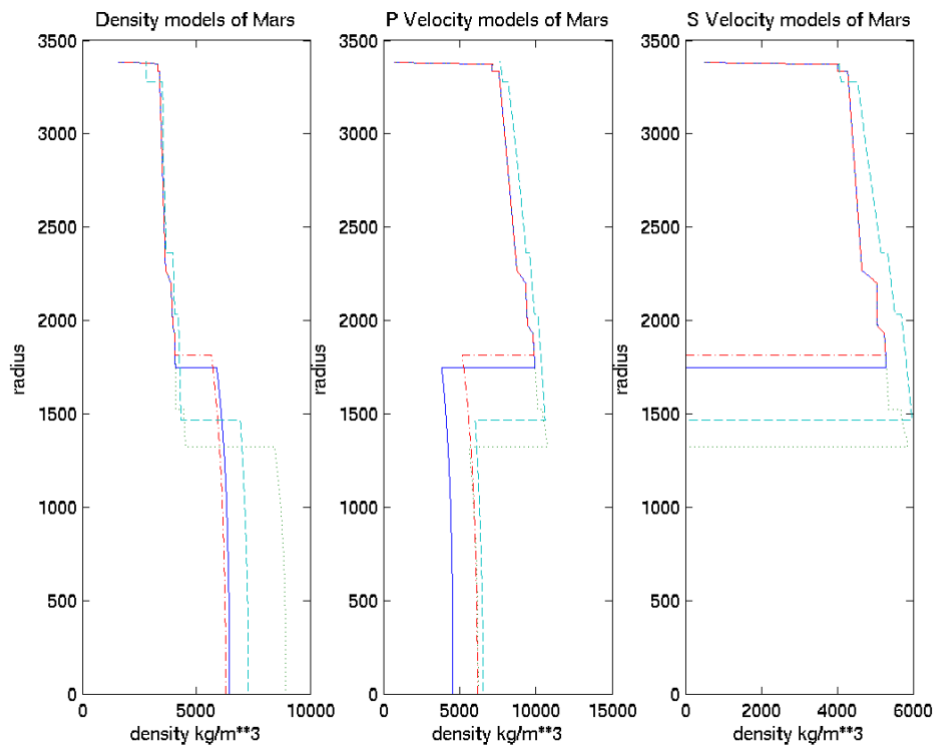


**Figure 7b :** Spectral amplitude on the Moon for a 24 hour record and at frequencies below 20 mHz, for a quake releasing a moment of  $10^{18}$  Nm at 30 km depth with strike, deep, rake angles of  $45^\circ$ ,  $45^\circ$ ,  $45^\circ$ . Such a quake is about 3 orders of magnitude greater than the strongest HFT quake Azimuth is  $20^\circ$  and the epicentral distance is  $90^\circ$

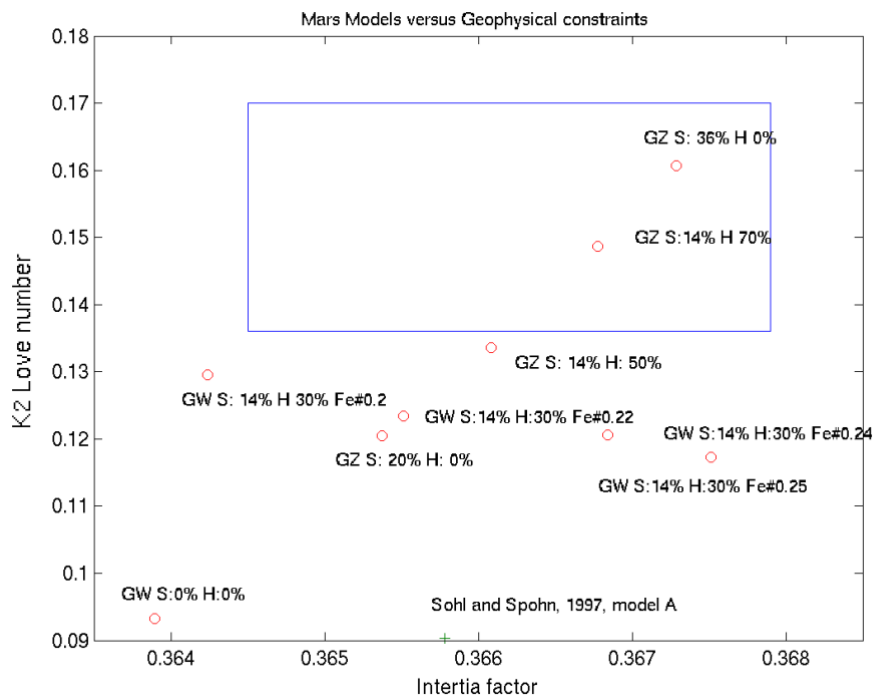


**Figure 7c:** Same quake and epicentral distance and azimuth, but on Mars. At 5 mHz, the amplitudes exceed  $1 \text{ ng}/\sqrt{\text{Hz}}$  and are a factor 4 greater than those observed on the Earth for an equivalent quake at equivalent epicentral distances. Note that below 10 mHz, the fundamental modes are associated to most of the signal.

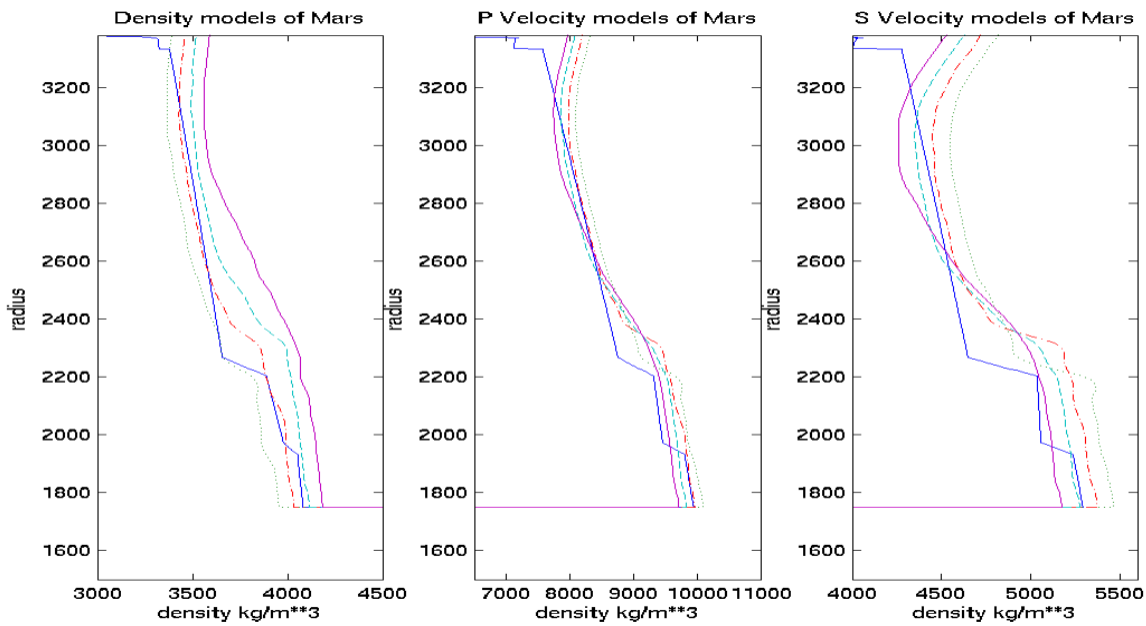




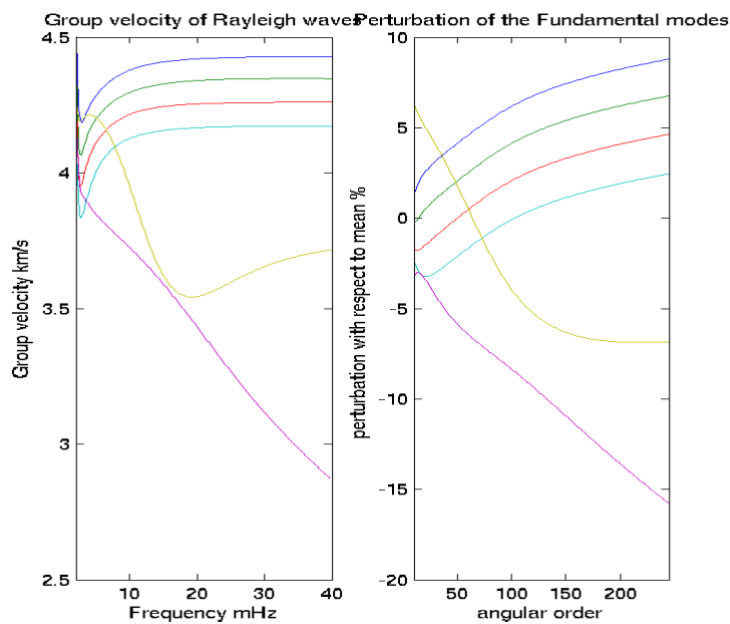
**Figure 8:** Models of Sohl and Spohn [1997], dashed line, and 3 models of *Gudkova & Zharkov* [2004]. The solid line and dotted line are for an hydrogen content in the core of 50% and 70%, with 14% of Sulfur in both cases, while the dashdotted line is for a sulfur content of 35% without hydrogen. *Sohl and Spohn* model has no hydrogen and 14% in sulfur.



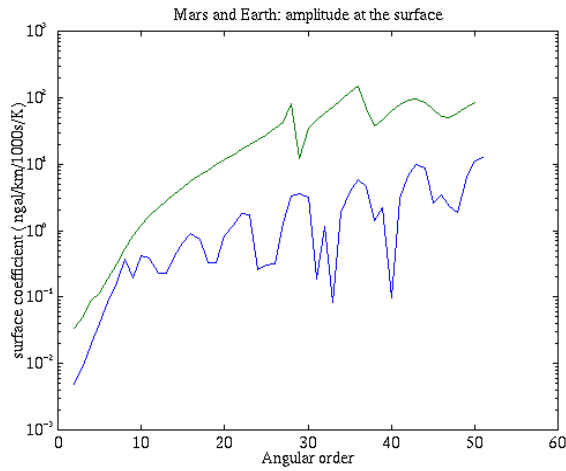
**Figure 9:** Fit of the observed and computer K2 and inertia factors for several models of *Sohl and Spohn* [1997] and *Gudkova and Zharkov* [2004]. The observed limits are enclosed in the box.



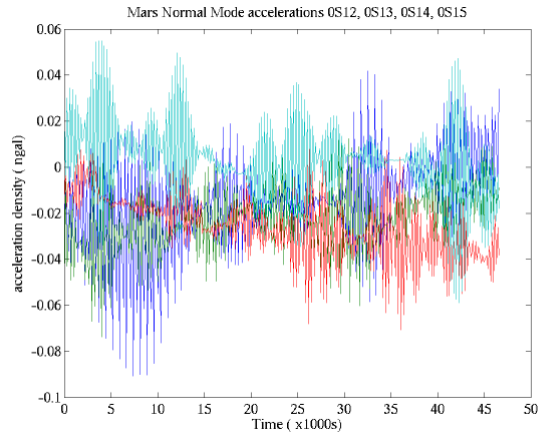
**Figure 10:** Mantle models of Mars, in term of density and seismic velocities for the model M7 of *Gudkova and Zharkov* [2004], continuous line, and the 4 models of *Mocquet et al.* [1996]. Models of *Mocquet et al.* [1996] have an increasing content of iron of 10,20,30 and 40 %, associated to dotted, dashdot, dashed and solid line. The main effect of an increase in Iron is to smooth the seismic discontinuities associated to  $\alpha$ -olivine to  $\beta$ -spinel and  $\beta$ -spinel to  $\gamma$ -spinel. *Gudkova and Zharkov* model has a 22% iron content in the mantle. The difference in depth of the discontinuities is mainly related to change in the core mantle boundary temperature. A temperature of about 2100K is taken at the CMB for the model of *Gudkova and Zharkov* [2004], while a more complex model, with temperature inversion in the mantle and mantle temperature about 500K colder at the depth of the discontinuities is take for *Mocquet et al.* [1996]. These colder temperatures shift the discontinuity to shallower depth.



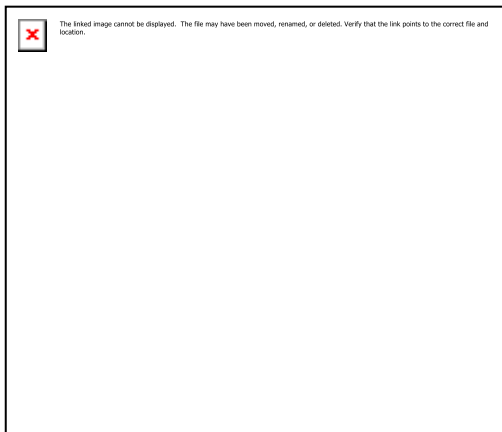
**Figure 11:** primary seismic observables for different mars models



**Figure 12a:** sensitivity of the normal modes to temperature fluctuations in the boundary limit, for the Rayleigh fundamental normal modes.



**Fig 12b:** Simulation of the permanent excitation of Normal Modes, for the spheroidal modes 0S<sub>12-15</sub> on Mars, with a GCM model. Color are blue, green, red and cyan respectively for increasing angular orders. Observed amplitudes on the Earth below angular order of 20 are 0.2 ngals.



**Figure 13a:** Fourier transformed amplitude of the P and S body wave packet. The amplitude is plotted with respect to frequency for different epicentral distances



**Figure 13b:** Maximum peak-to-peak amplitude in the frequency band with respect to epicentral distance.

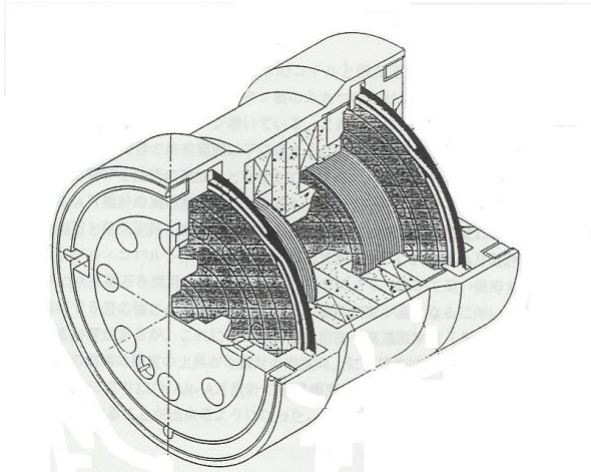


Figure 14a : Sketch of the Lunar-A sensor head. The diameter is 5 cm and sensor head mass is 354g

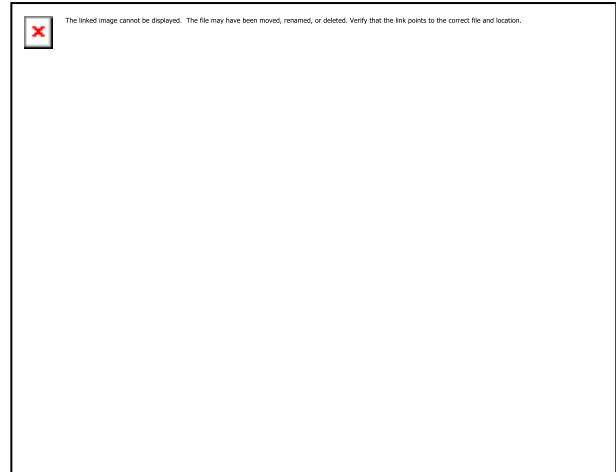


Figure 14b : Optimism sensor head. Diameter is 8 cm. Sensor head mass is 120g

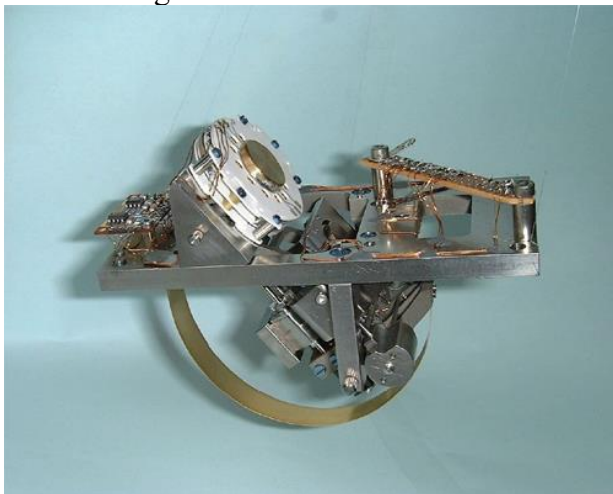


Figure 14c : VBB-SEIS sensor head (177.2g)



Figure 14d : SP suspension (sensor head 15g)

	Lunar A	Optimism	VBB-SEIS	SP-SEIS
Number of Sensors and free period	One vertical, One horizontal, 1-1.2Hz	One vertical 2 Hz	Two obliques 0.5 Hz	3 obliques 10 Hz
Complete mass	3500 g	840 g	2000 g	
Resolution at 1 Hz and 5Hz	1.25 x 10 <sup>-10</sup> m 0.20 x 10 <sup>-10</sup> m (5 Hz)	5x10 <sup>-10</sup> m	< 0.125x10 <sup>-10</sup> m	<1.25 x 10 <sup>-10</sup> m <0.05 x 10 <sup>-10</sup> m (5 Hz)
Maximum sampling rate and dynamic	16 sps, 12 bits	4 sps, 16 bits	20 sps, 24 bits	100 sps, 24 bits
Consumption	175 mW	67,5mW	450 mW	
g-load	10000g	200g-20 ms	200g 20ms	200g 20 ms

**Table 2:** Main performances and characteristics of the different developed or in development seismometers. The sensor mass is the mass of the pendulum, while the complete mass is for all the instrument, including its installation mechanism (when available, as for the VBB-SP SEIS package) and control and acquisition electronics.